

Sejtek önszerveződése



Czirók András, ELTE Biológiai Fizika Tanszék

Önszerveződés: kapcsolat szerveződési szintek között

“**Mikroszkopikus**” szint: objektumok és kölcsönhatások



“**Makroszkopikus**” szint: mintázatok, rendszerszintű viselkedés

Klasszikus fizikai példa: halmazállapot változások

molekulák közti kölcsönhatás: van der Waals (Lennard-Jones)

halmazállapotok: állapotegyenletek, mechanikai tulajdonságok, stb.

Közlekedési dugók: Önszerveződés dinamikai (nemeqyensúlyi) rendszerben

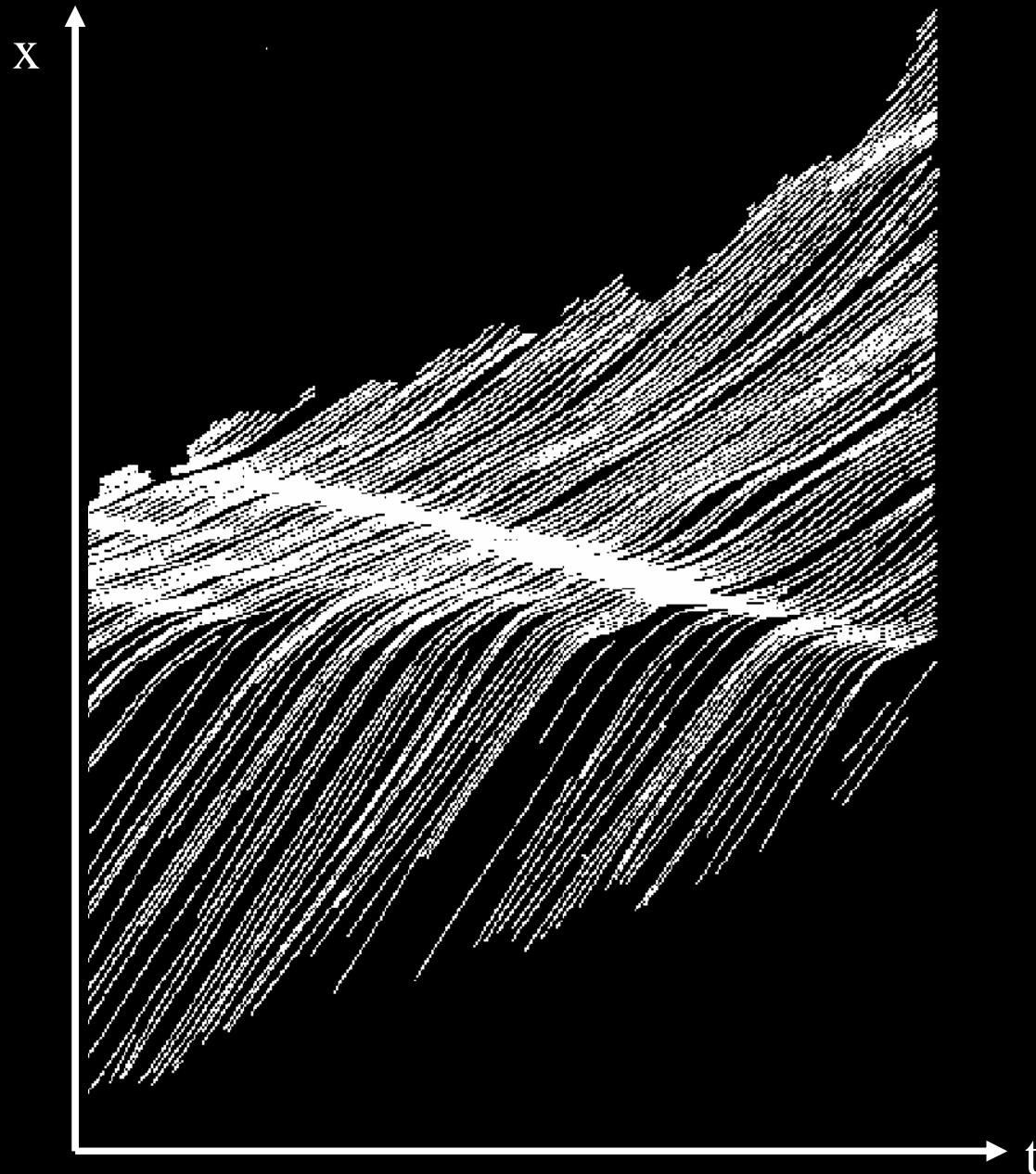

Treiterer & Myers
1974

Mikroorganizmusok úszása:

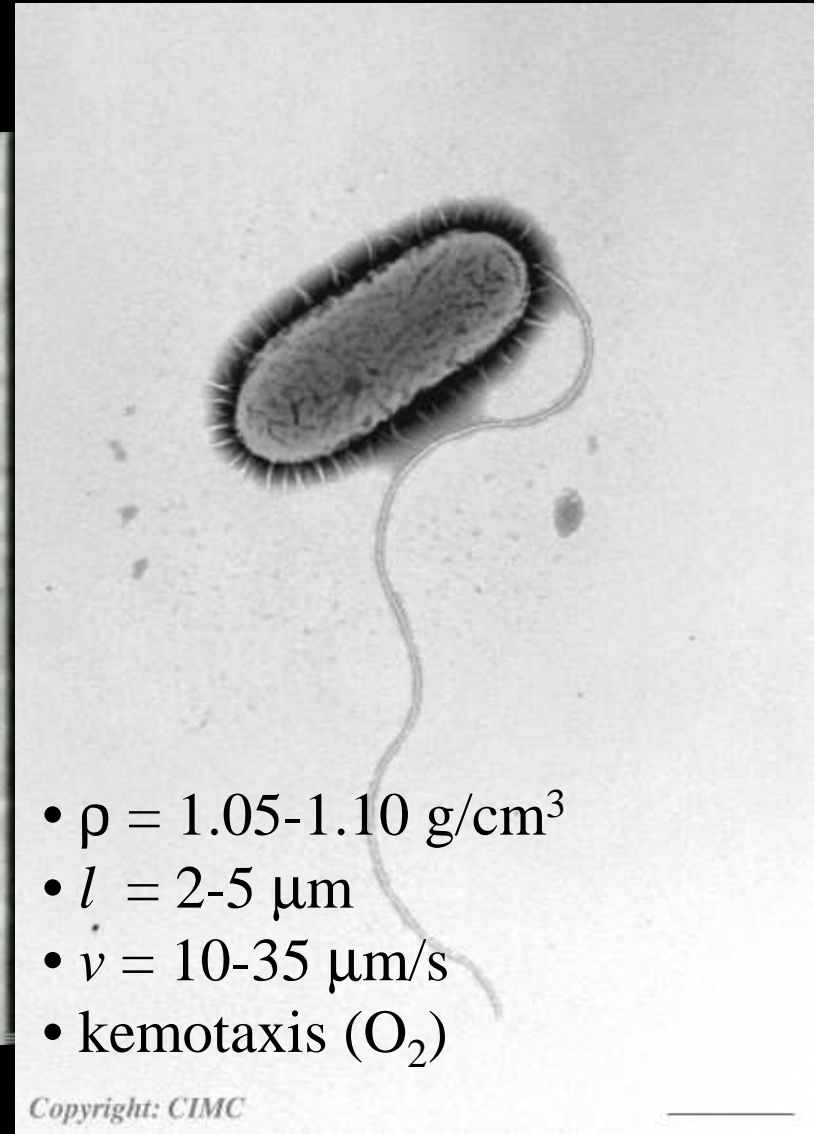
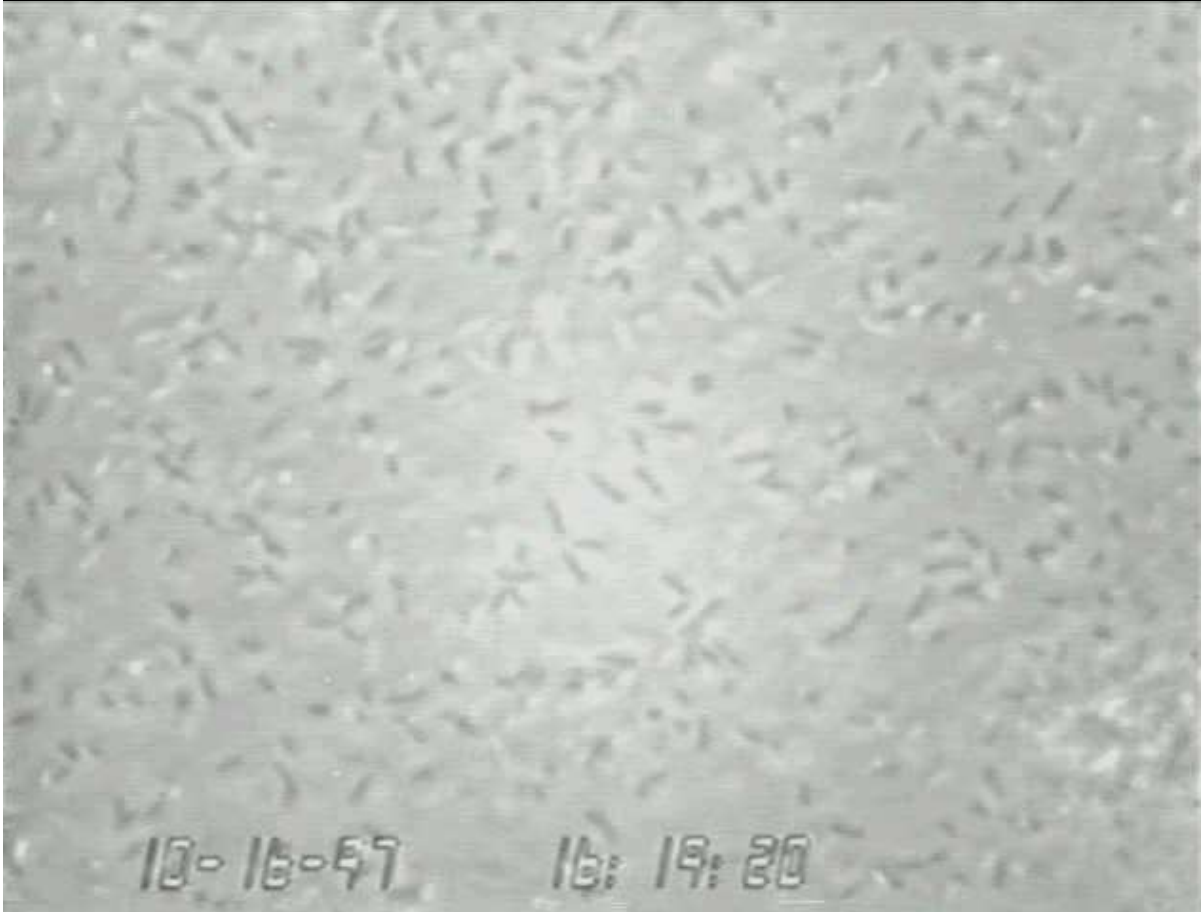

Biokonvekció: Mikroorganizmusok által hajtott folyadékáramlás

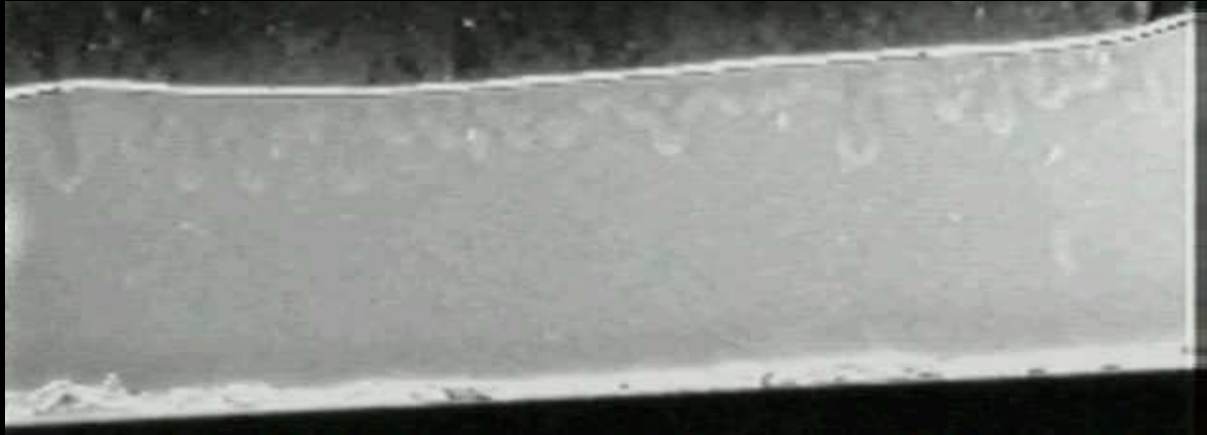

Hajtóerők:

- mikroorganizmusok úszása
- kemotaxis (oxigén)
- sűrűségkülönbség

Jánosi Imre, ELTE
John Kessler, U Arizona

Biokonvekció -- felülnézet



Jánosi Imre, ELTE
John Kessler, U Arizona

Nagy sűrűség – önhajtott, turbulens folyadék

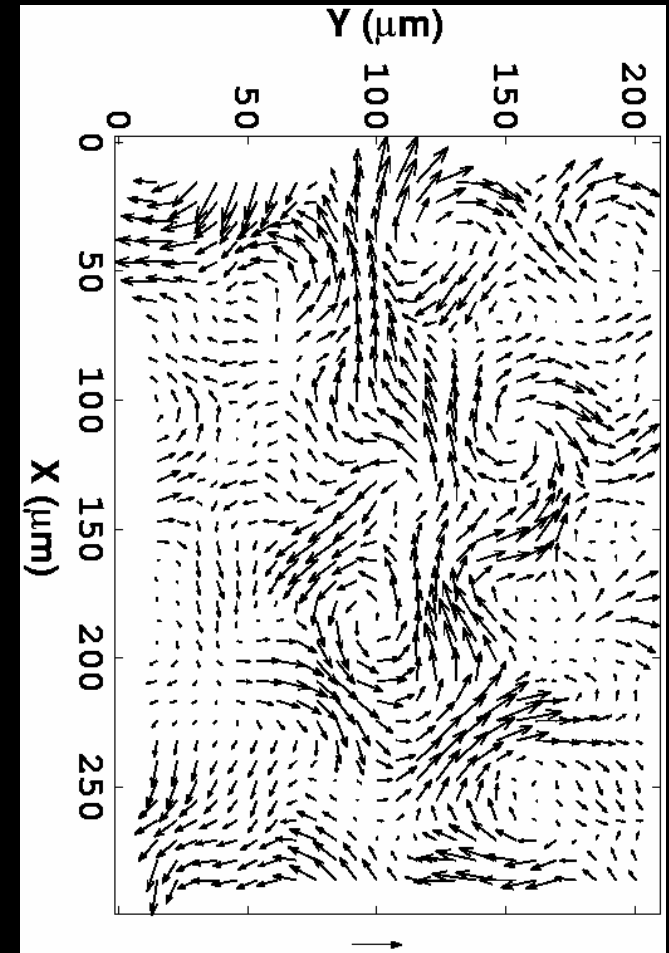
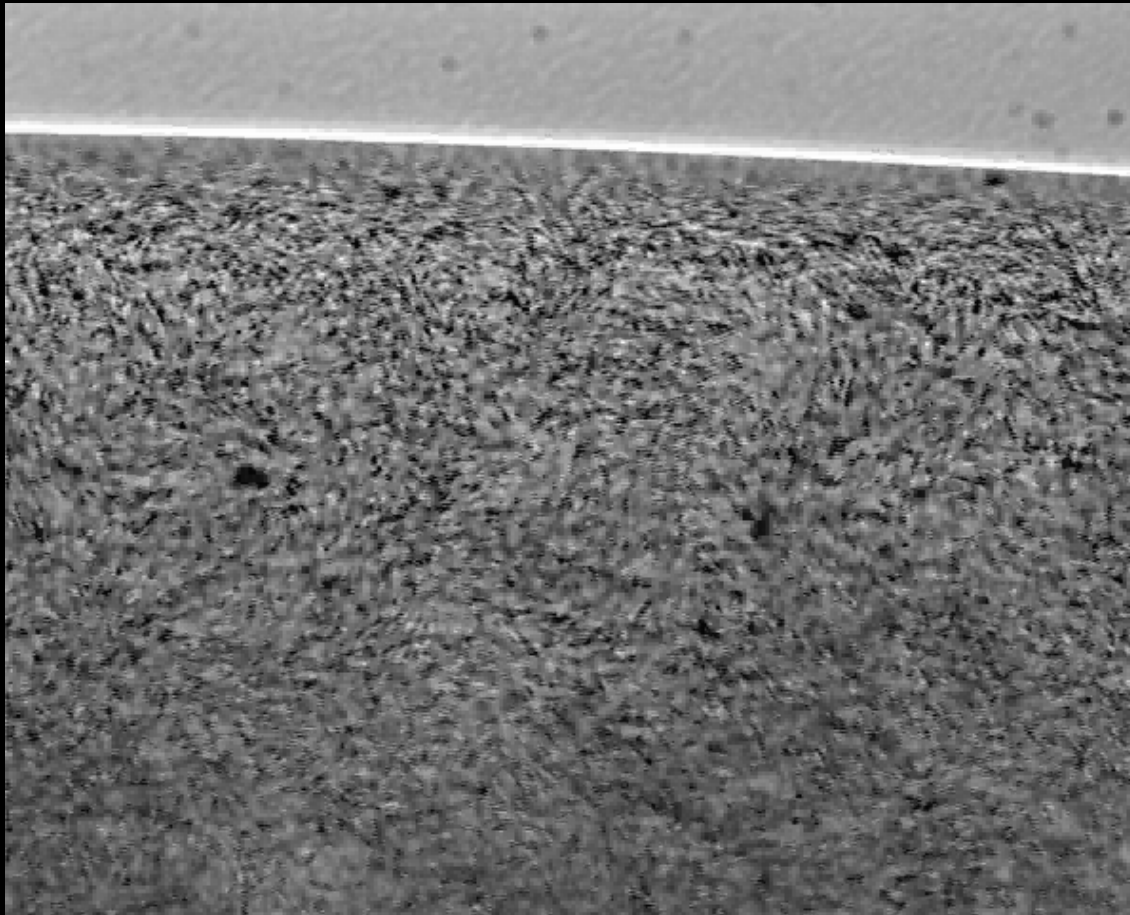

Raymond Goldstein, U Arizona

Szöveti sejtek áramlása

Emberi
glioblasztóma
sejtek

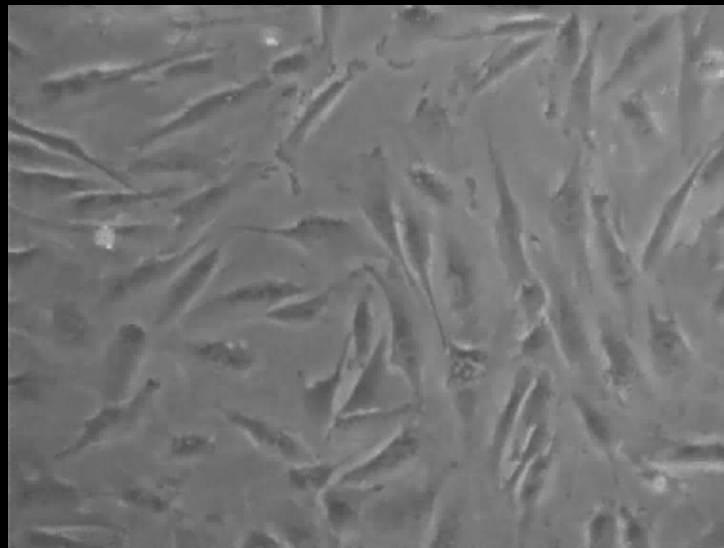

Hegedűs Balázs, ELTE

Aorta sejtek

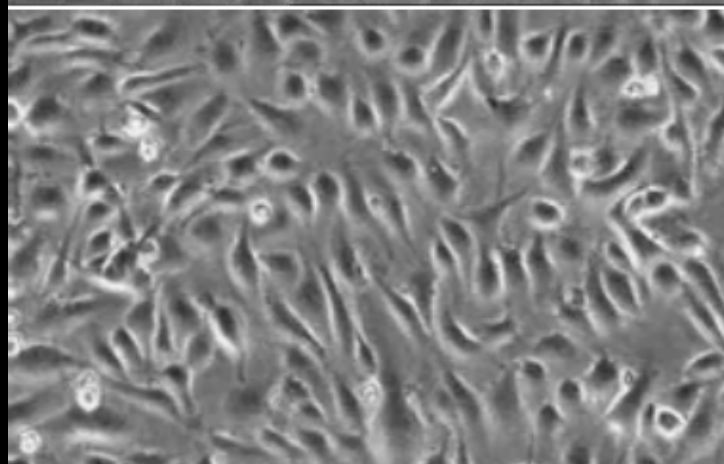

Waleed Twal, MUSC

Önhajtott folyadék
(hidrodinamikai modell)

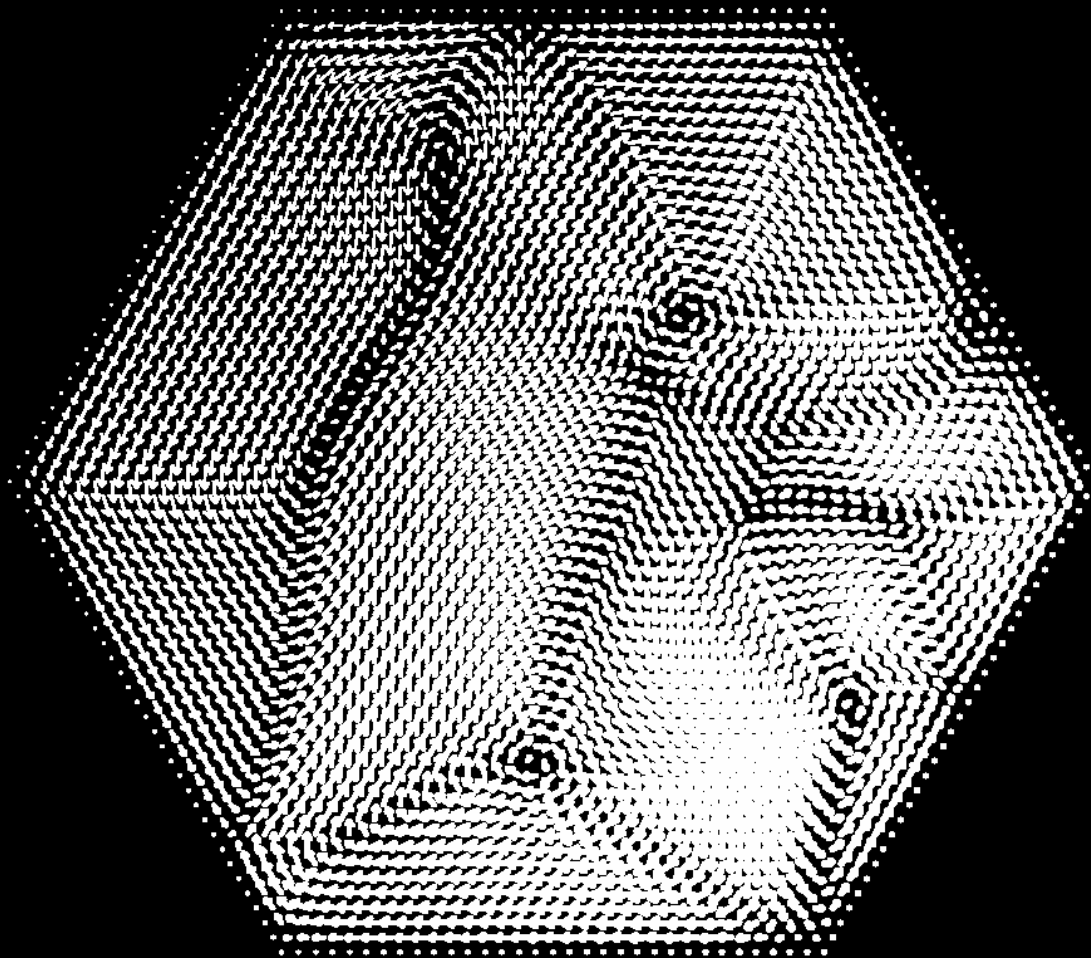

Csahók Zoltán, Vicsek Tamás
ELTE

Érhálózat önszerveződés

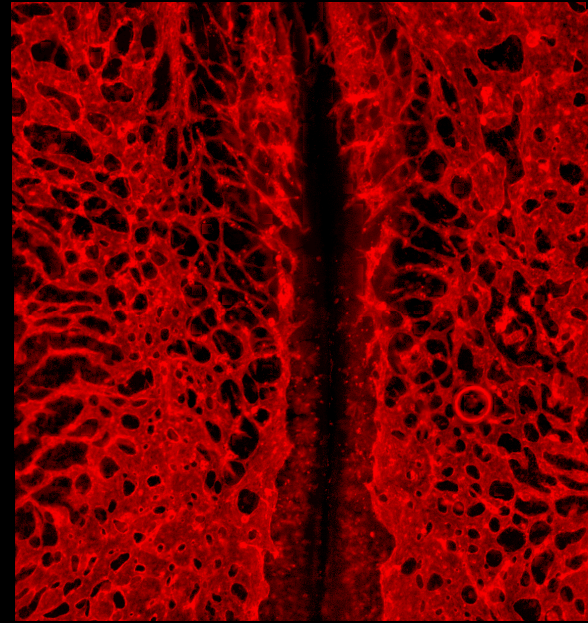
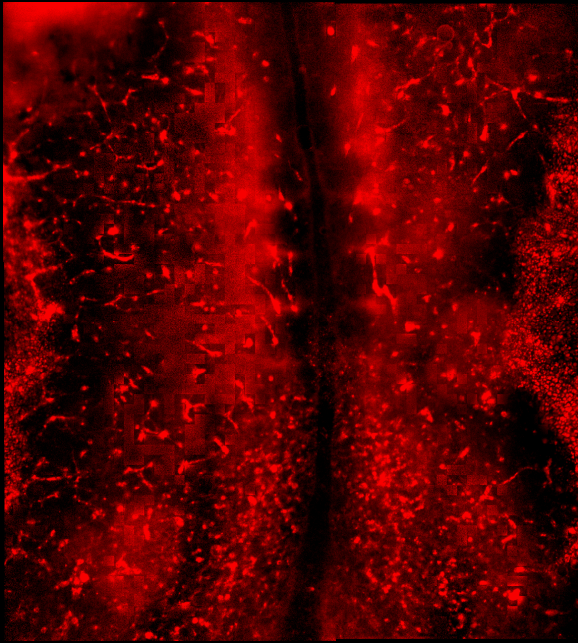

?

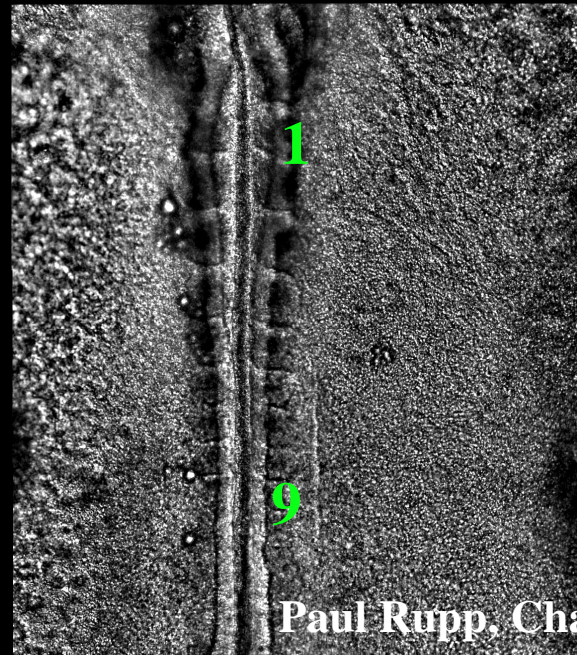
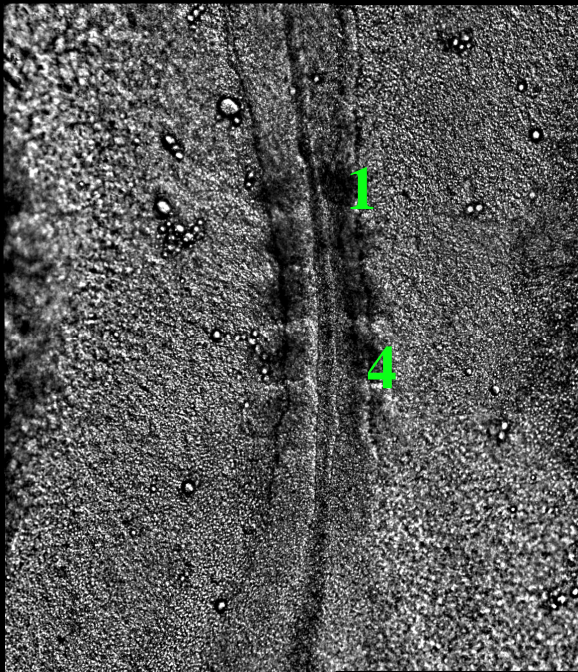
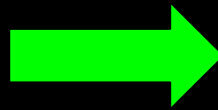

Paul Rupp, Charles Little
U Kansas

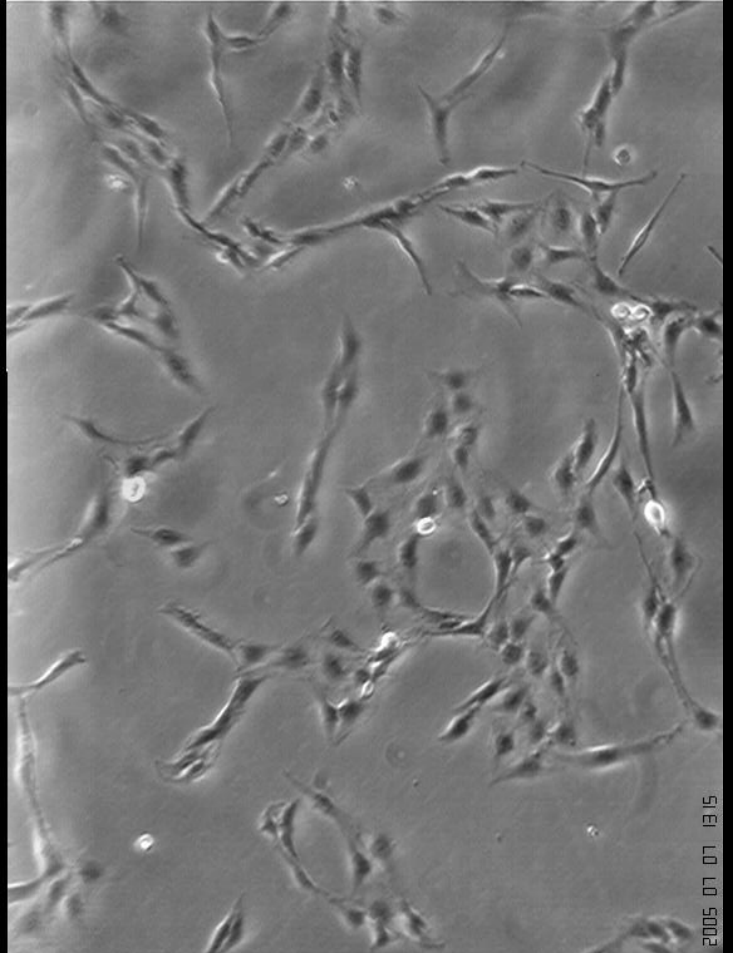
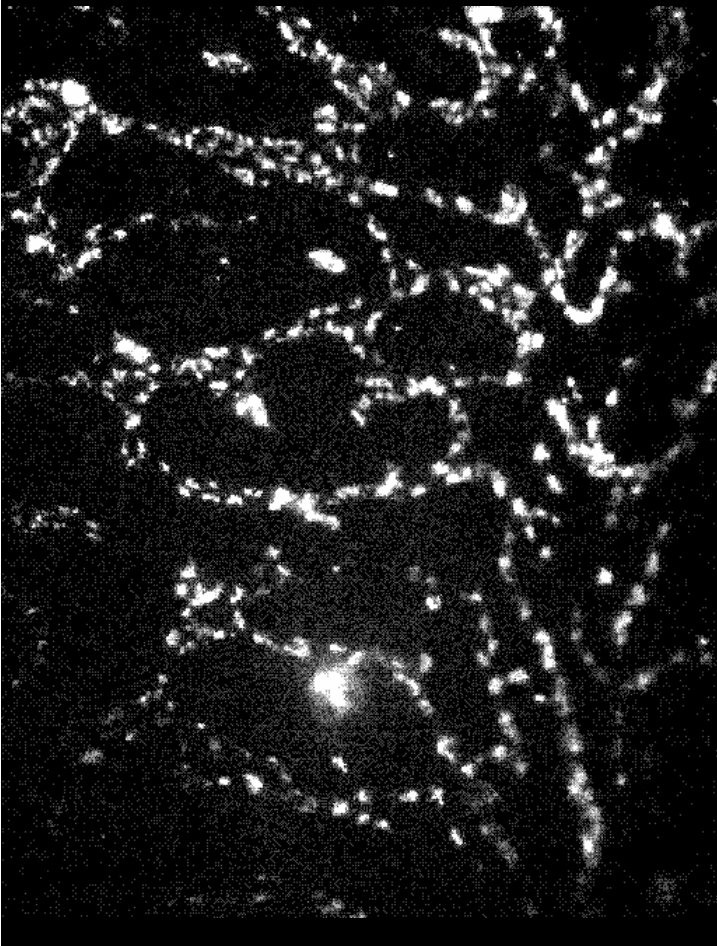
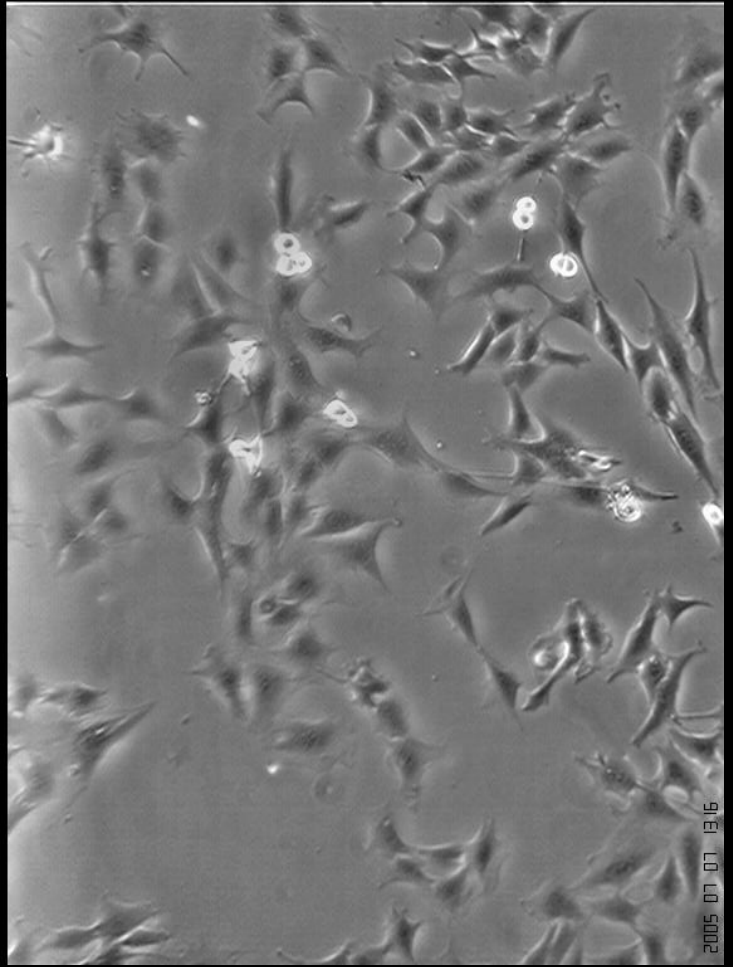
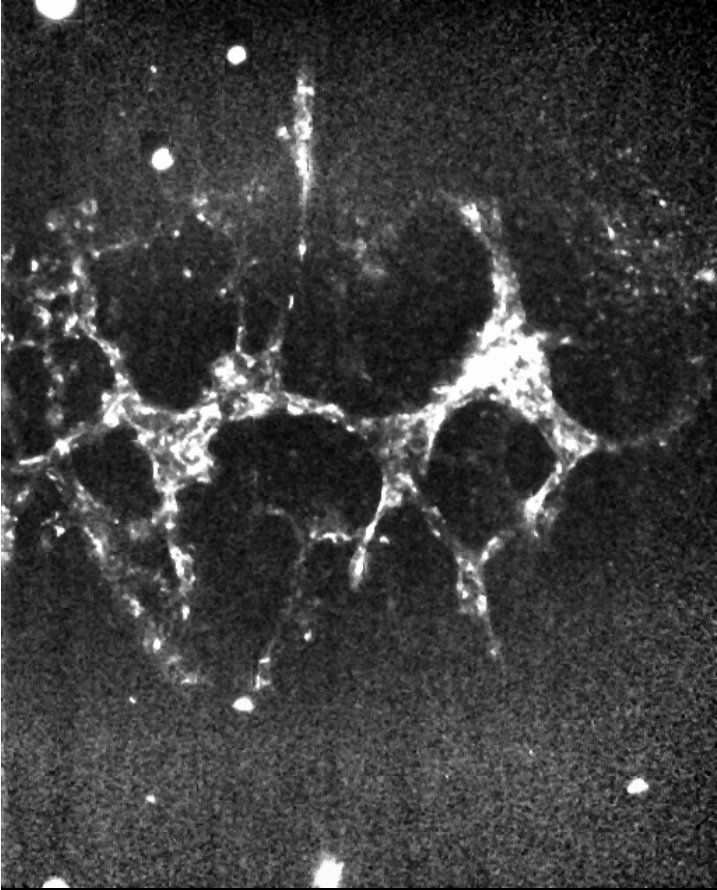

Hálózat-formálás tenyészetben

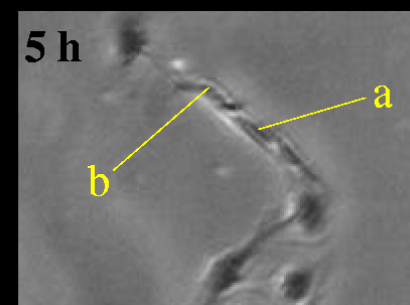
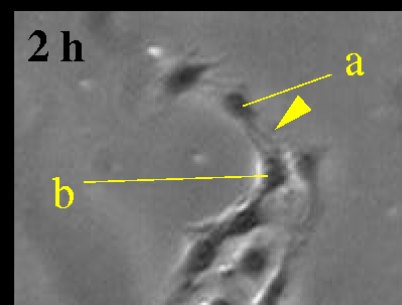
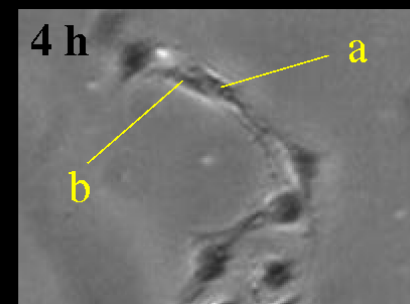
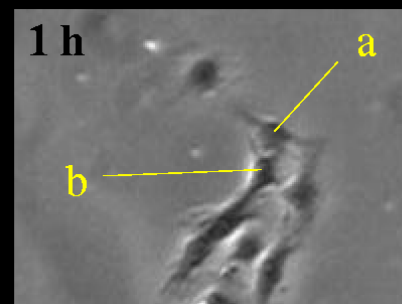
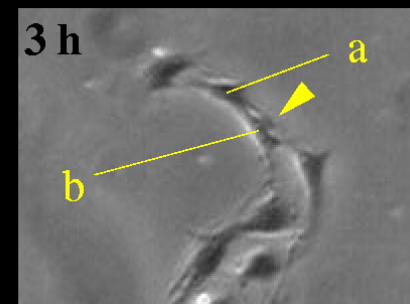
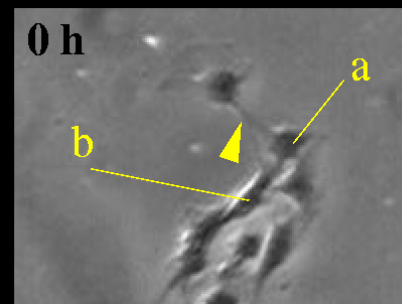

Szabó András, Méhes Előd
ELTE

Hálózat-formálás modellje

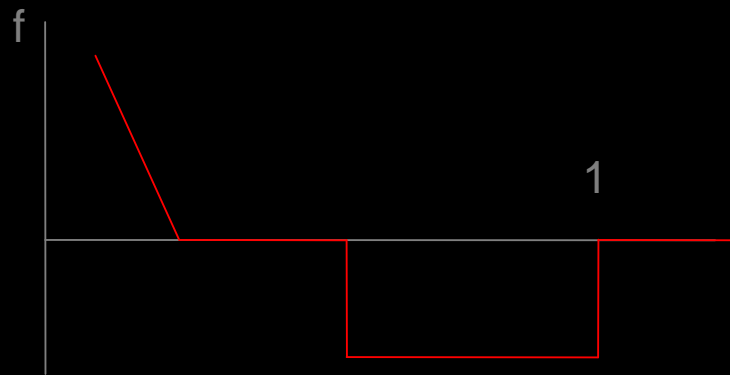

Erőhatás a szomszédos részecskék között.

Vonzás arányos a részecske környezetének anizotropiájával

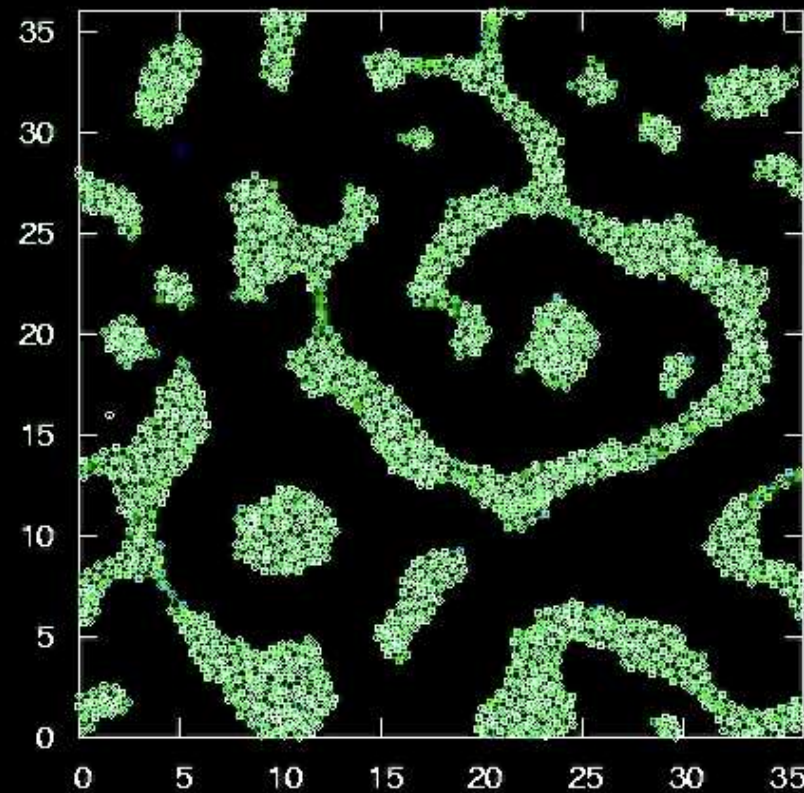
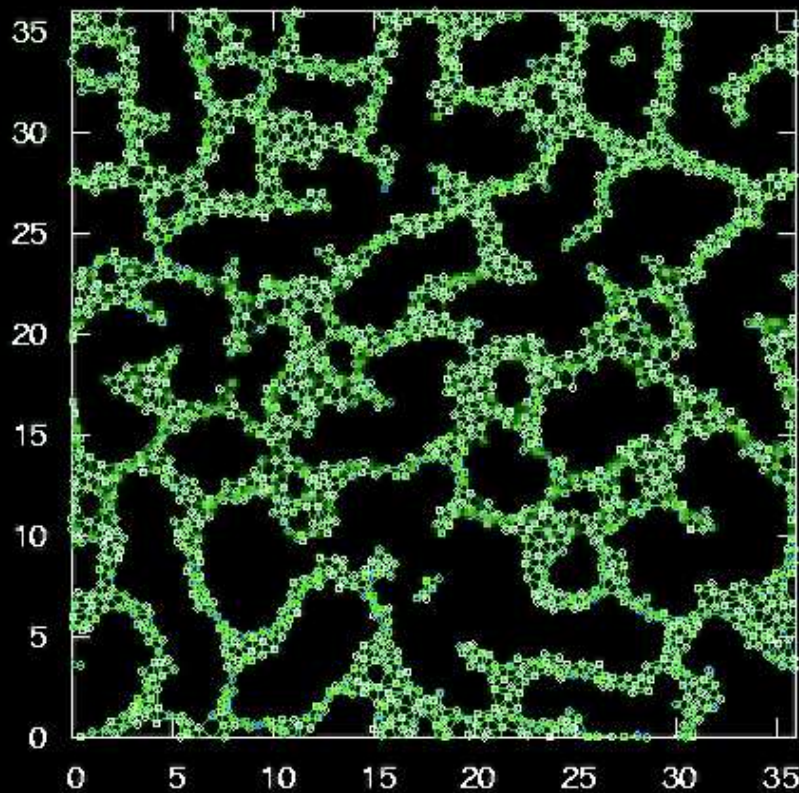

Korai madárembriók szerkezete

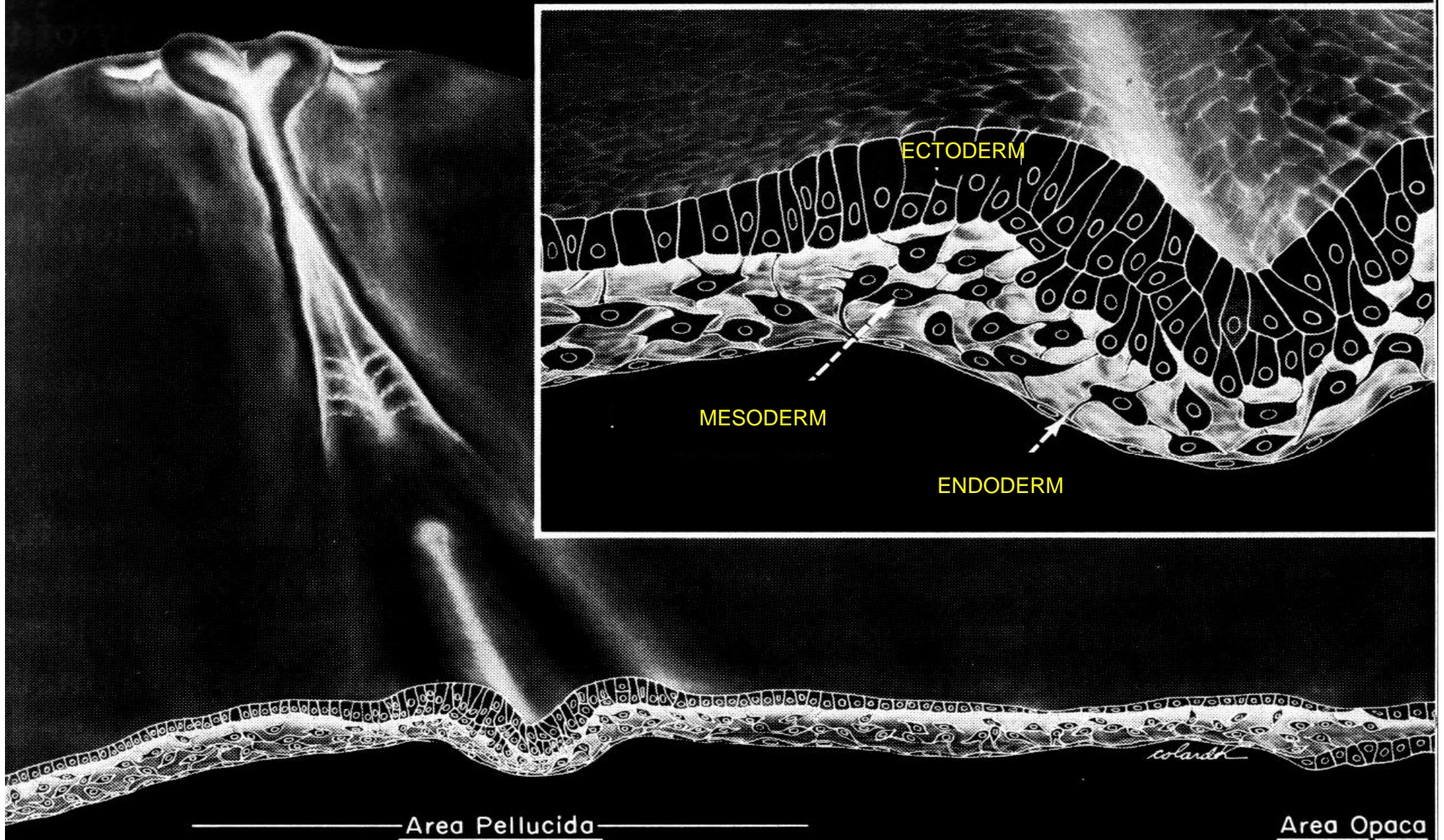

E. Hay, 1968

Vizsgálati módszerek:

1. Embriók életben tartása a tojáson kívül
2. Mikroinjektált reagensek
3. Automatizált mikroszkópia
4. Adatelemzés

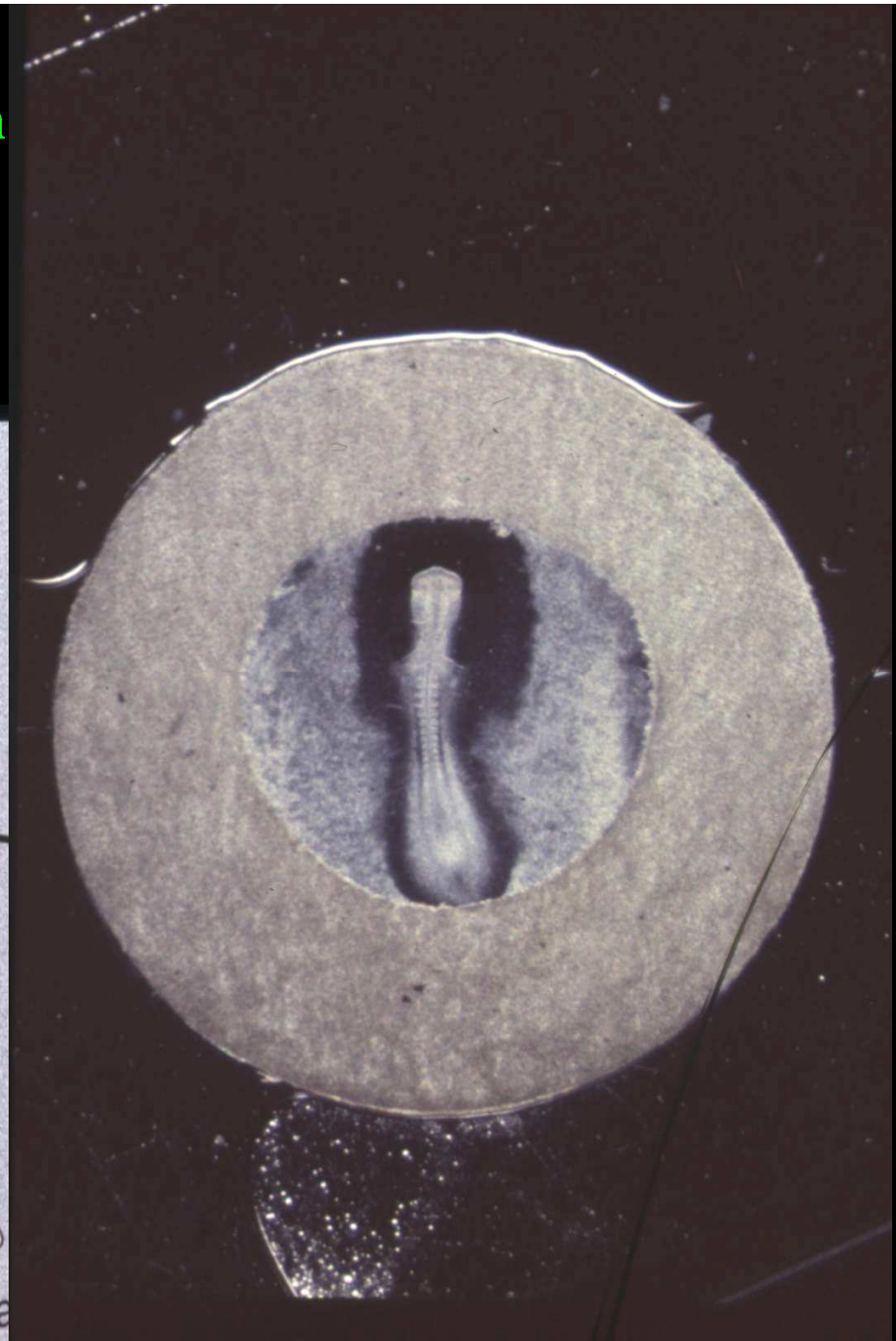
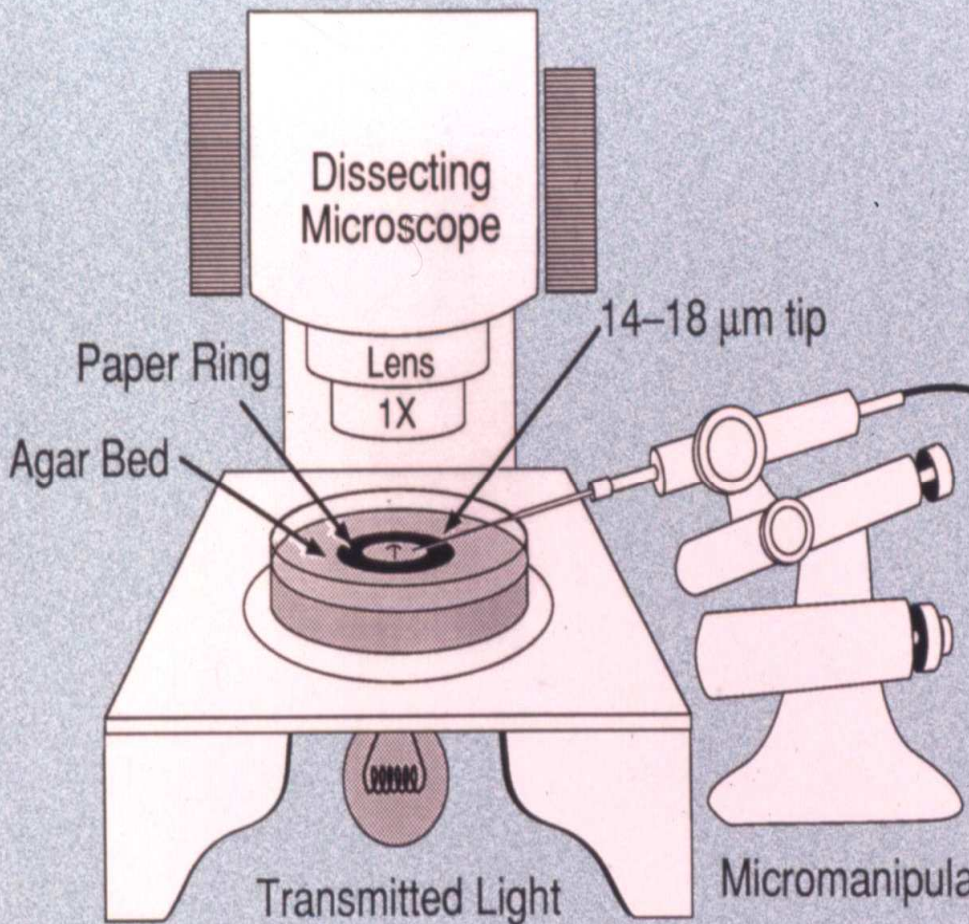

Mikroszkópia:

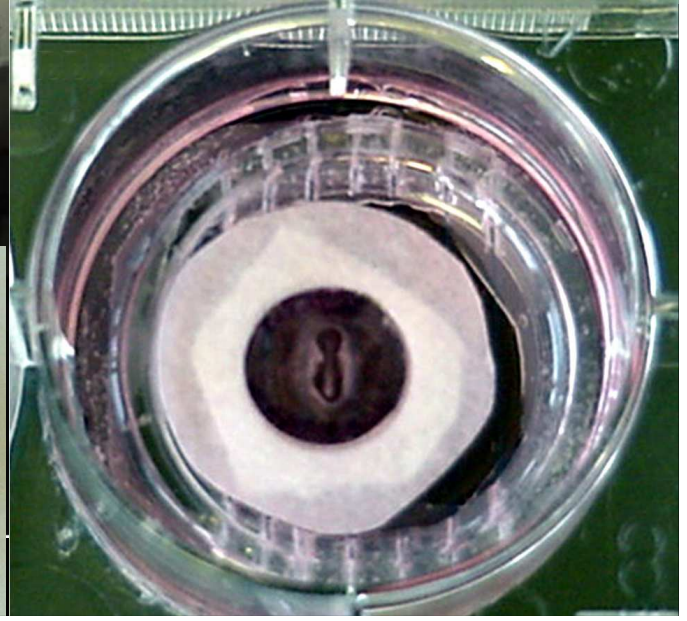
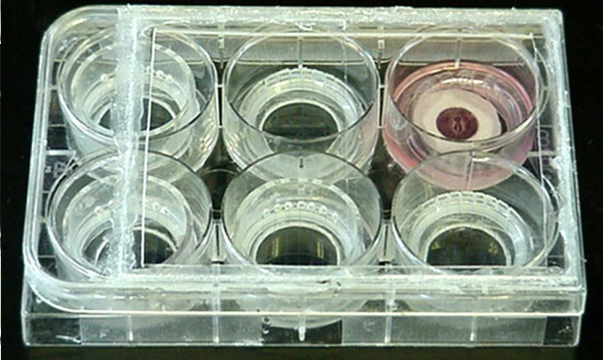
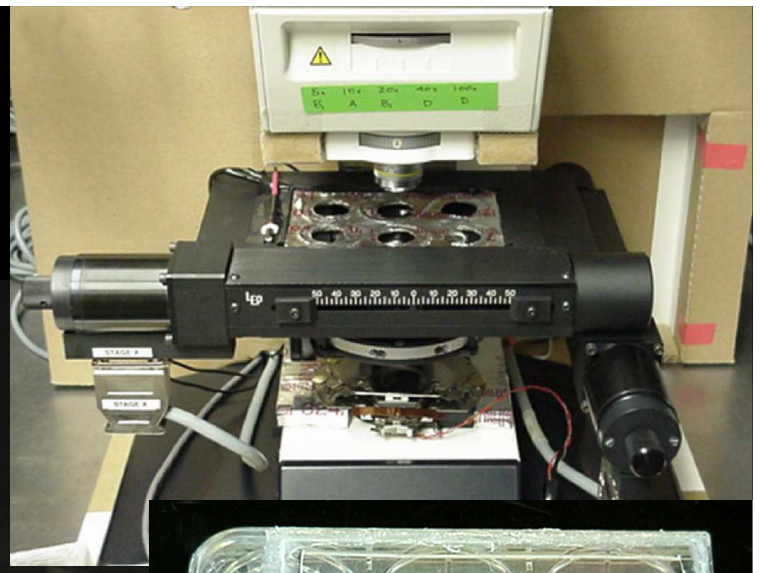
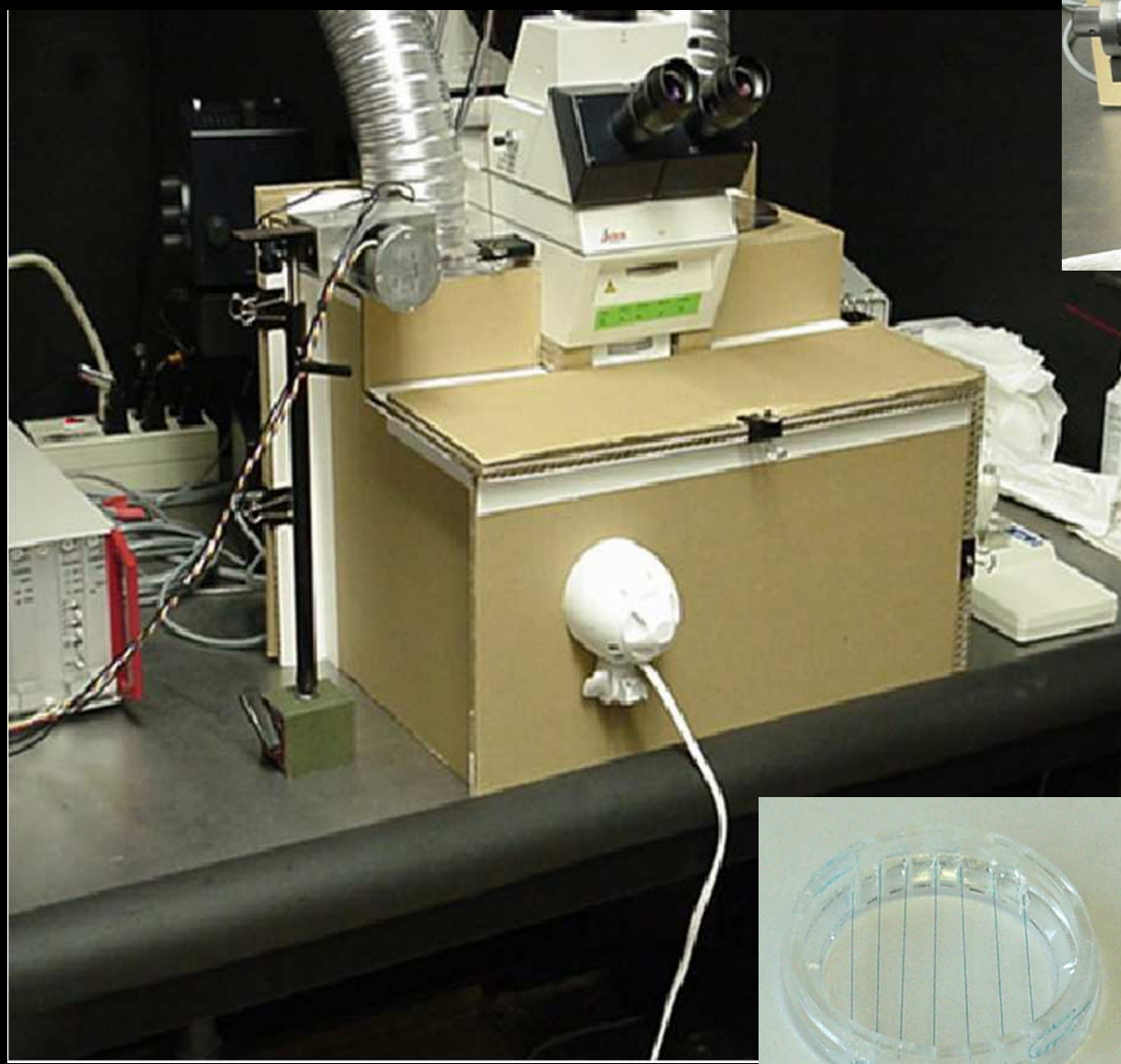

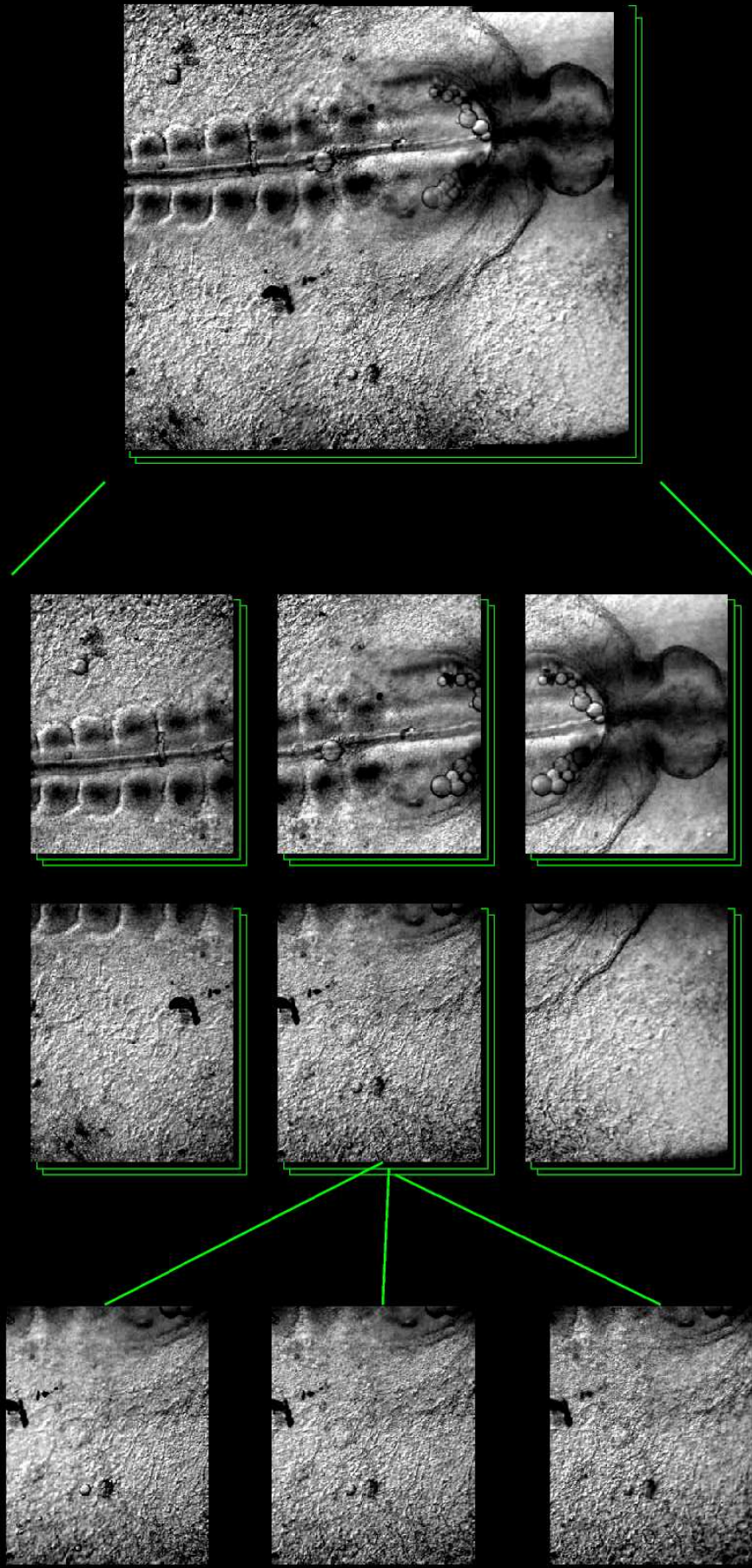

merged image

overlapping microscopic fields

z-stack

$z = 10 \mu\text{m}$

$z = 0 \mu\text{m}$

$z = -10 \mu\text{m}$

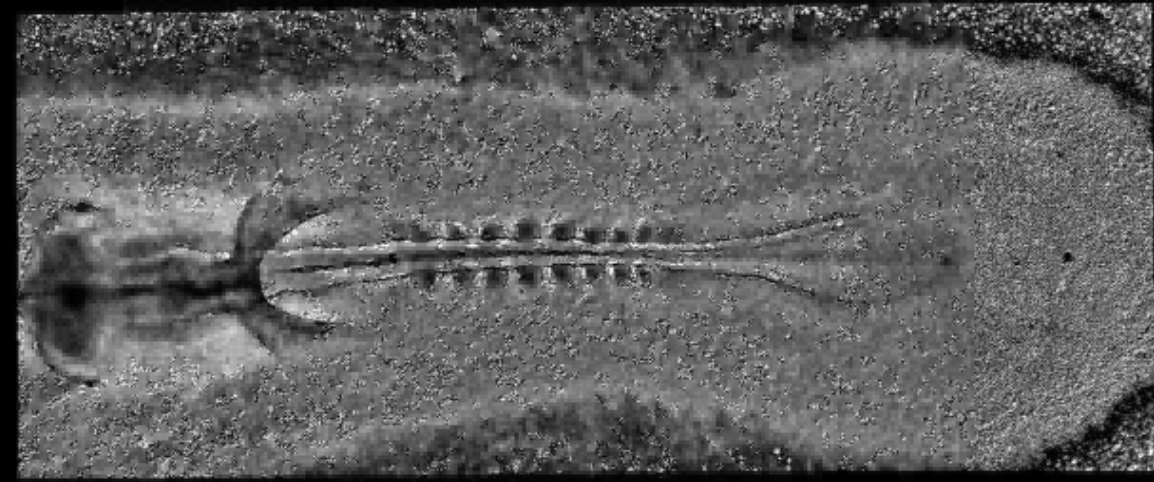

0.2mm: —

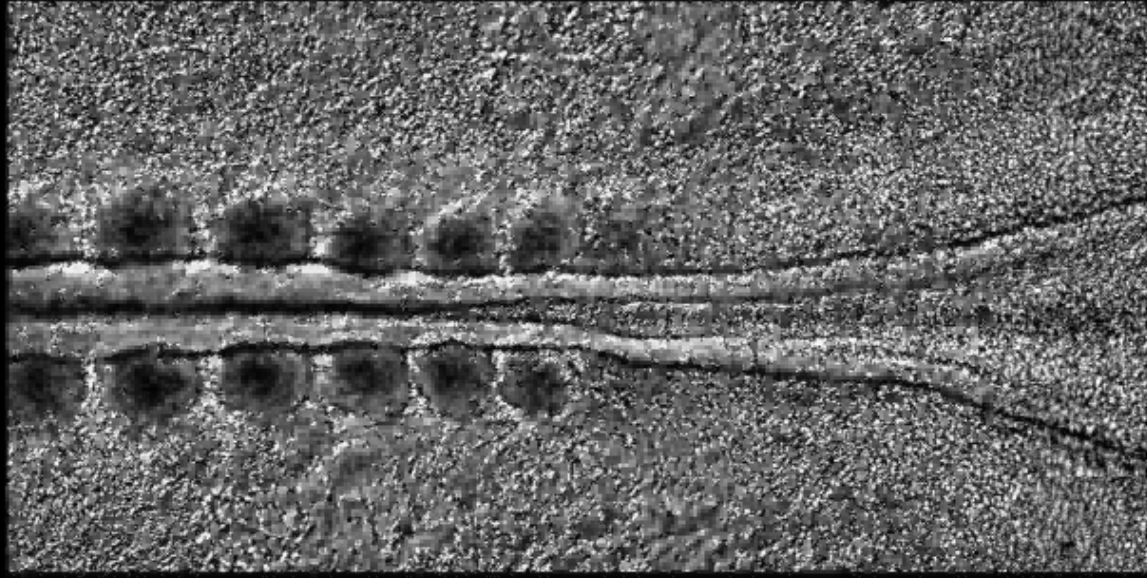

—

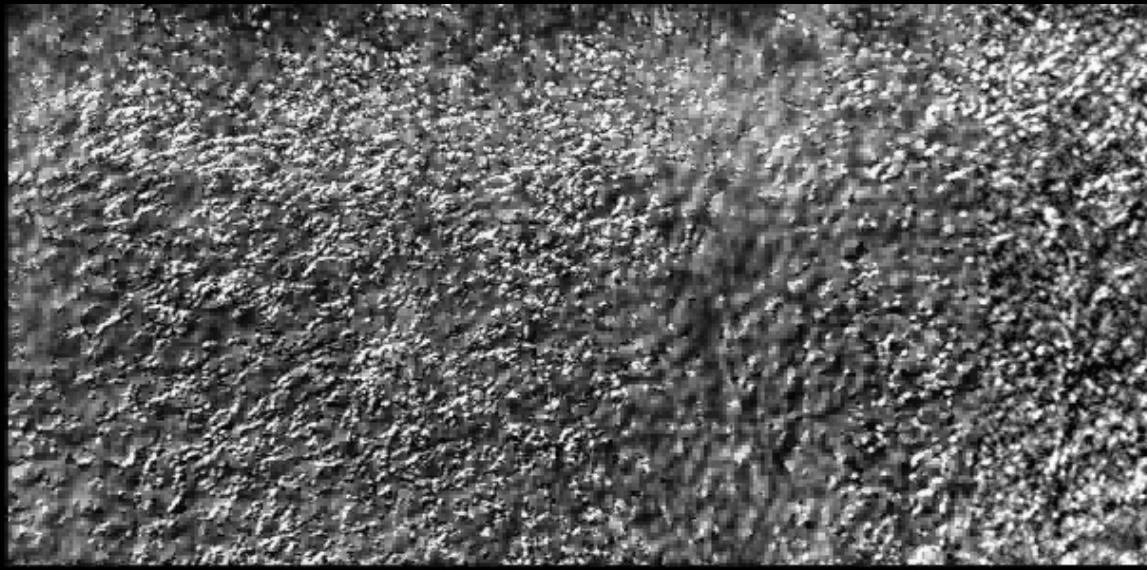

—

Time : 00.0 hours

Az embrionális érhálózat kialakulása

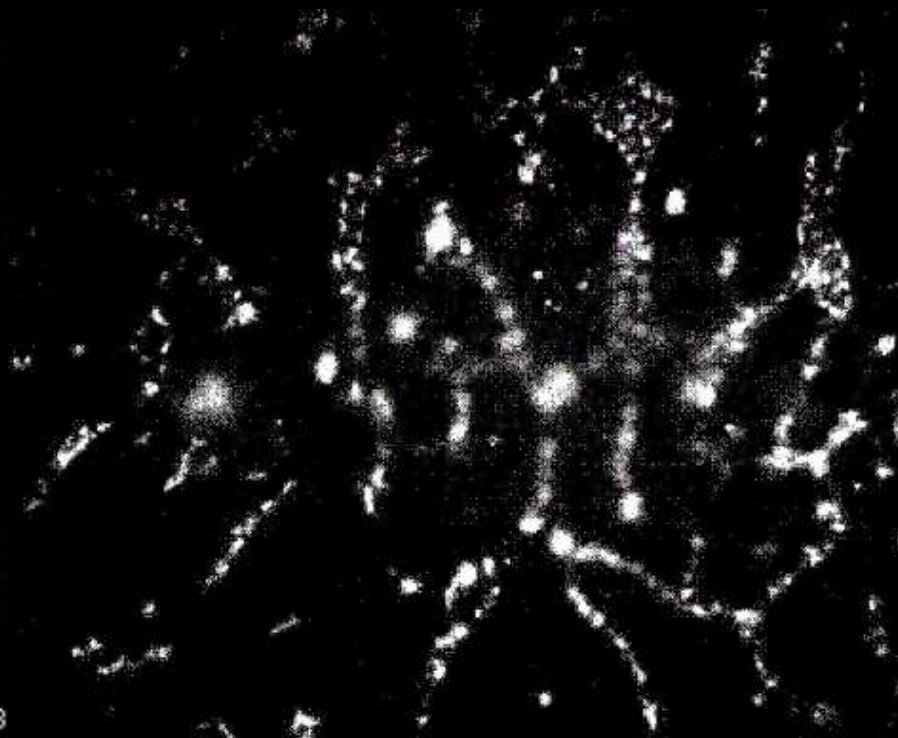
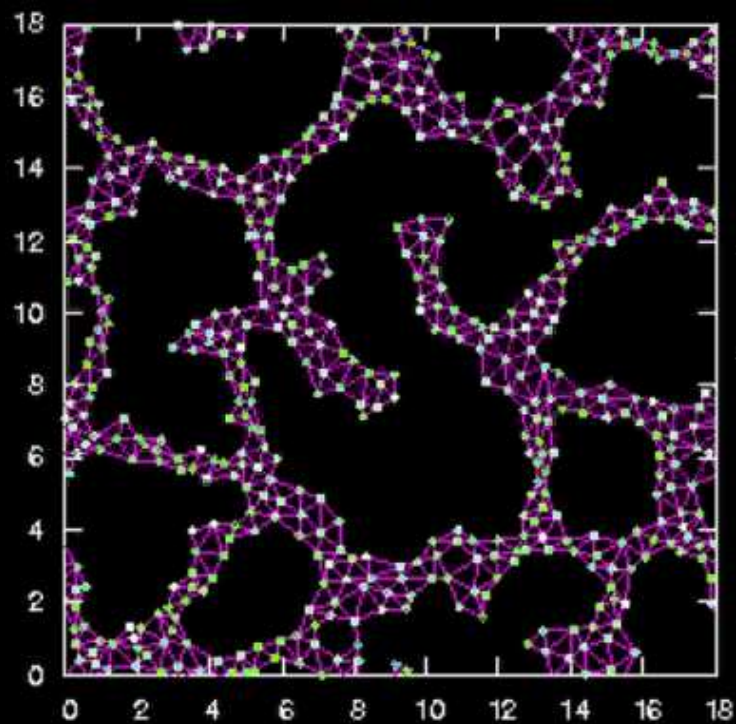

Az embrionális érhálózat kialakulása

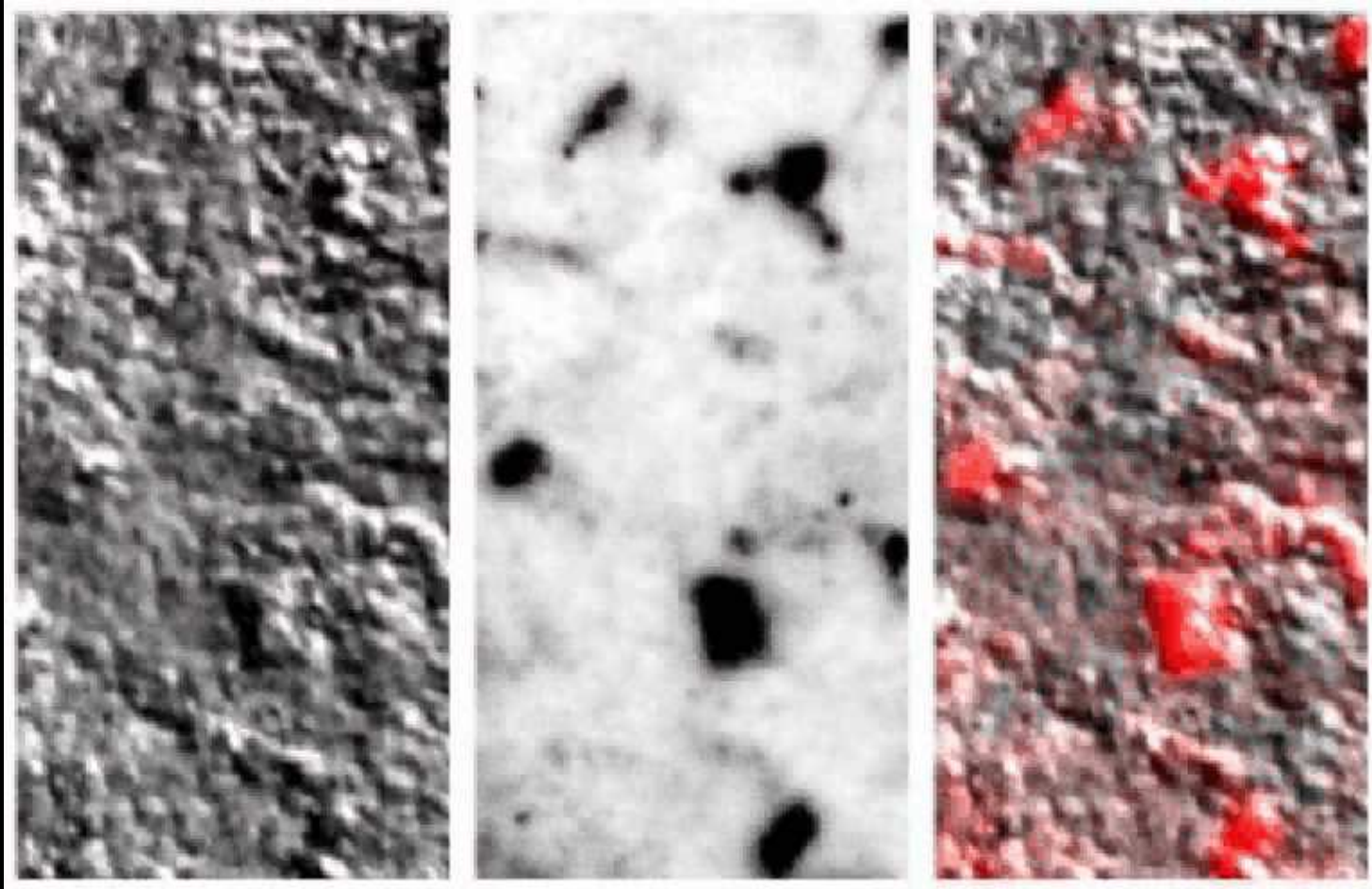

Paul Rupp, Charles Little
U Kansas

A sejtmozgás intenzitása szabályozható

VEGF

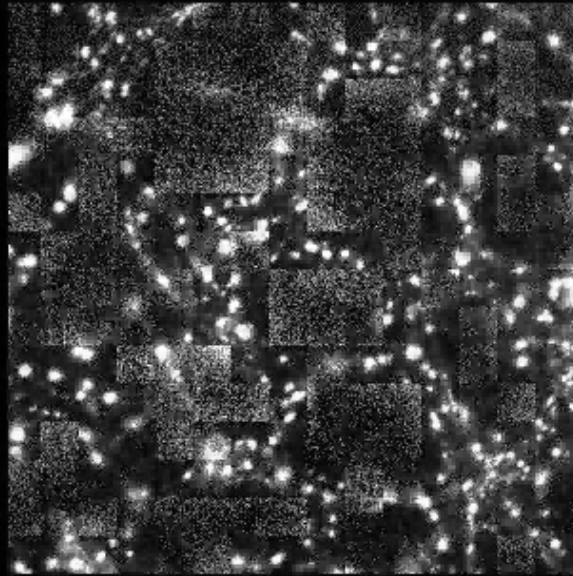

CONTROL



Paul Rupp, Charles Little
U Kansas

Áramlások az embriófejlődés során

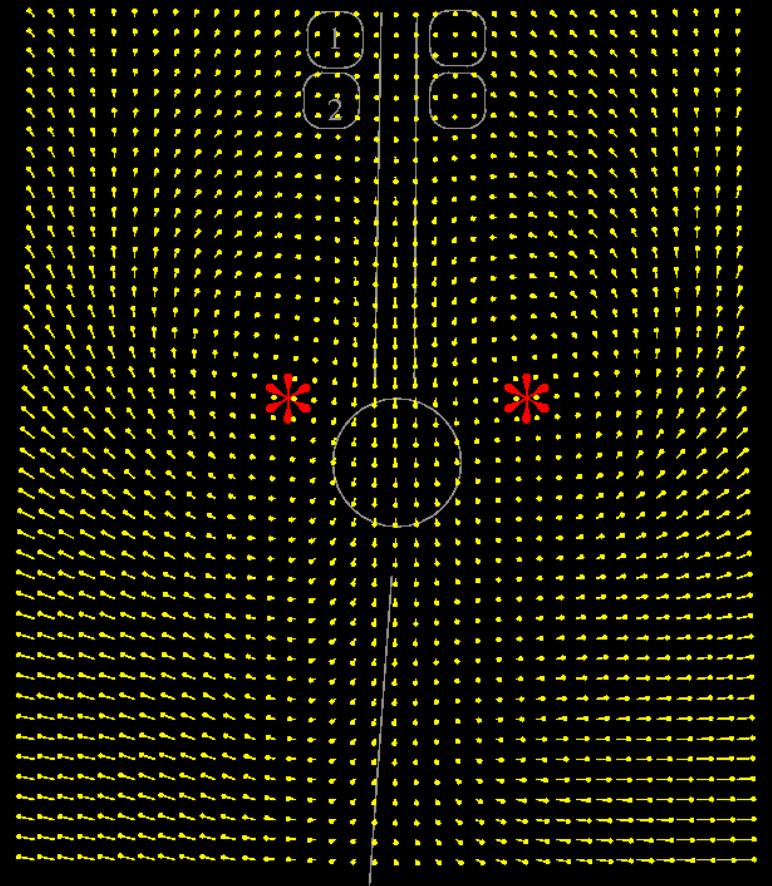
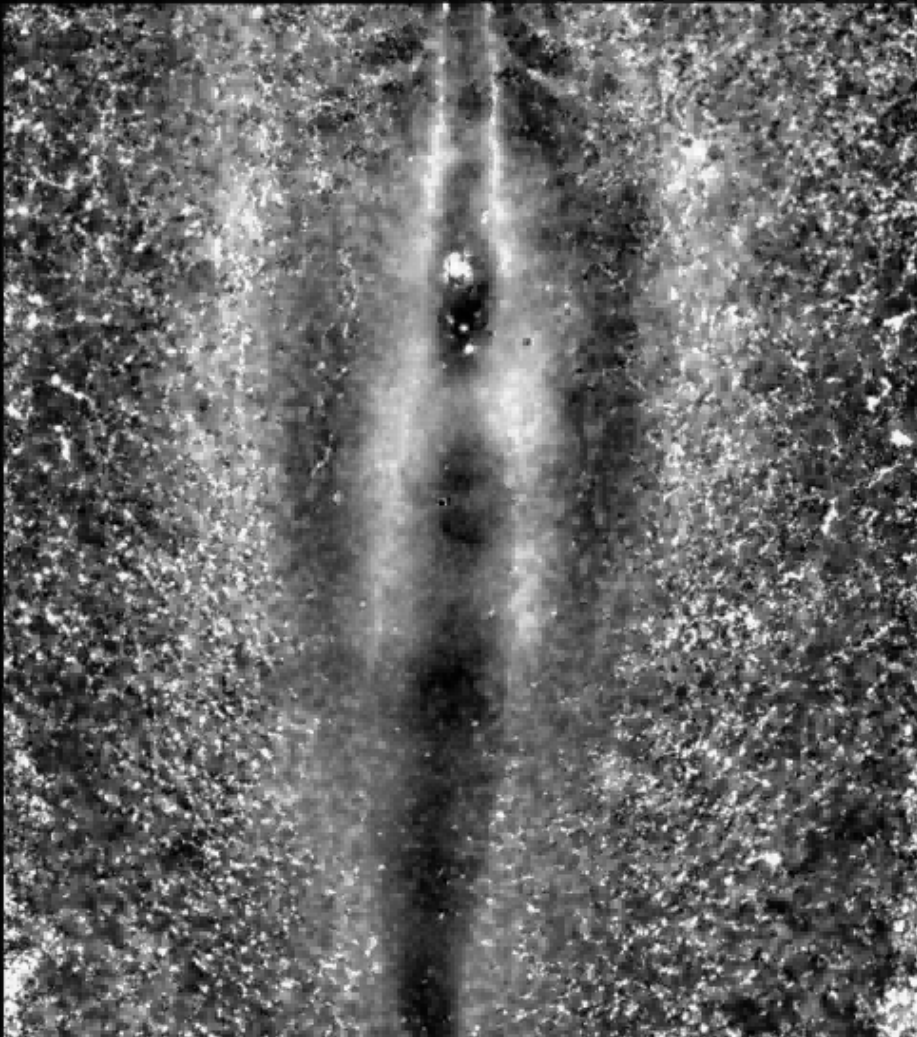

Brenda Rongish, Evan Zamir, Charles Little
Univ. of Kansas

Erők mérése

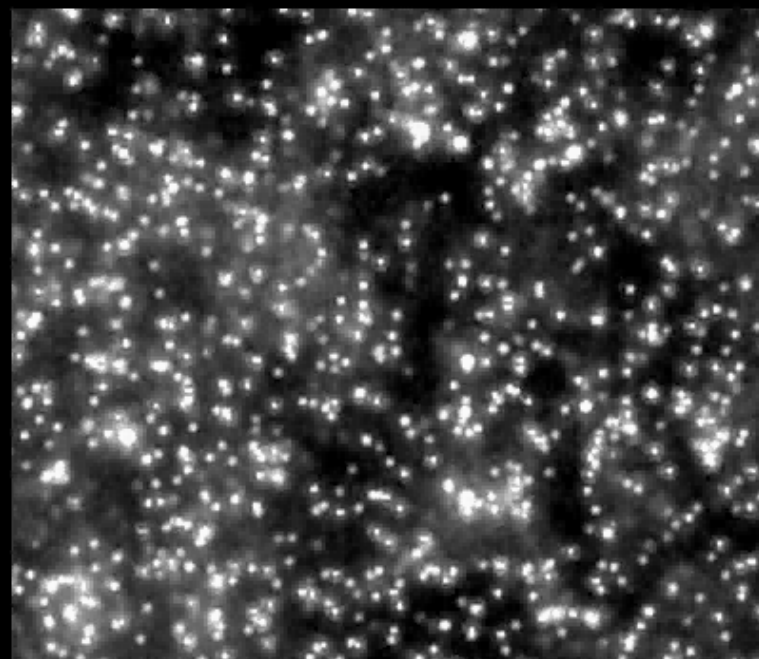
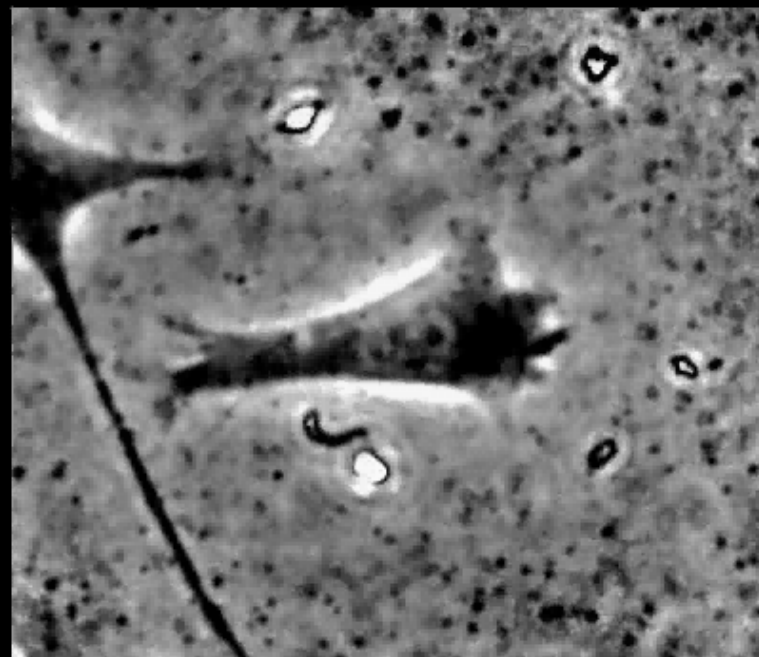
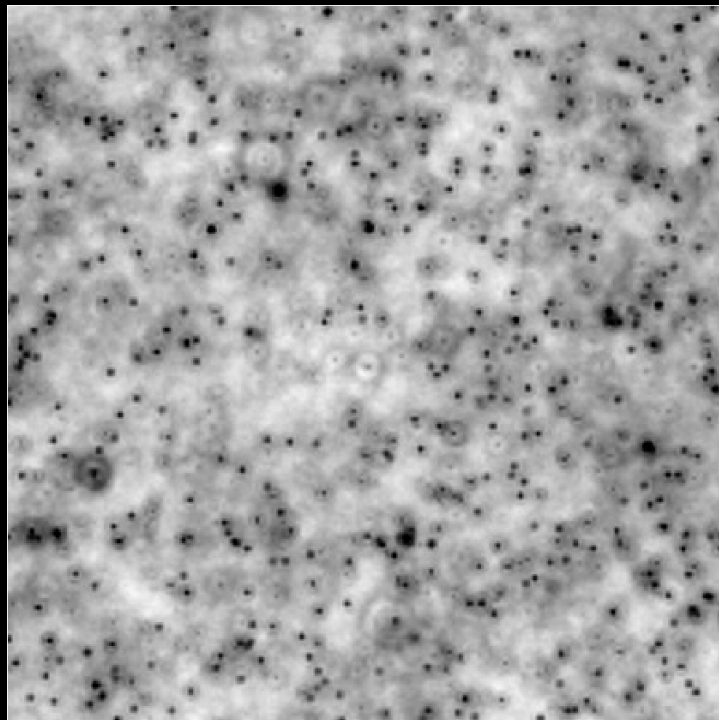

Géldeformációk sejtmozgás közben

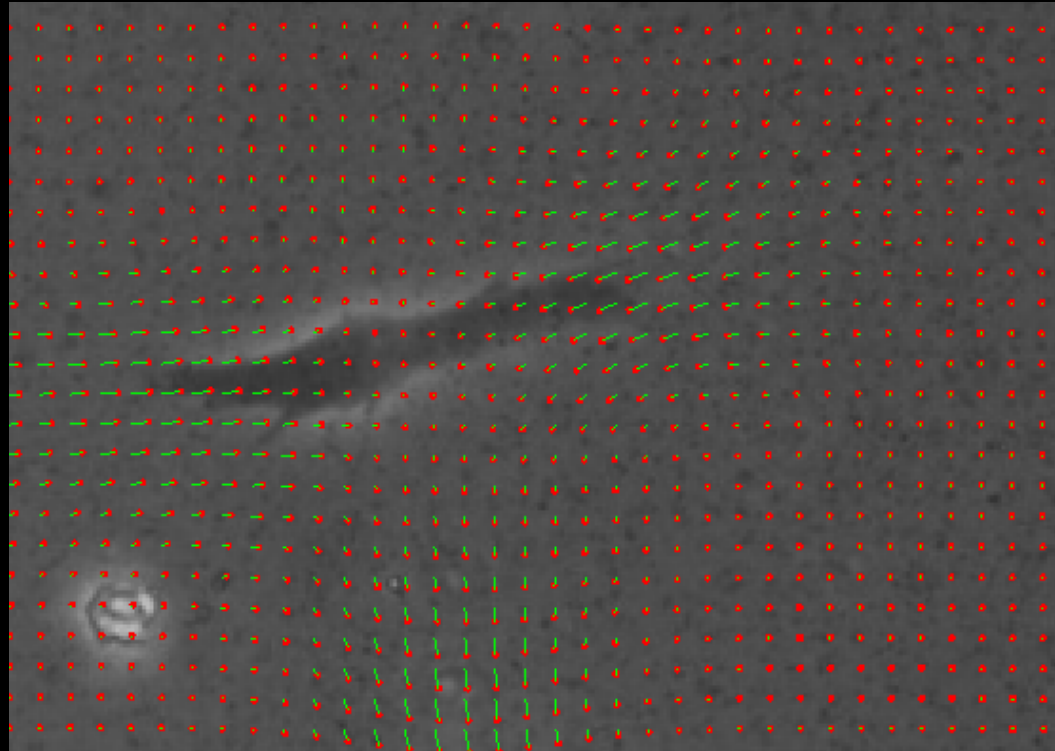

Az embrionális szövetek folyadékok: relaxálni tudják a nyiróerőket

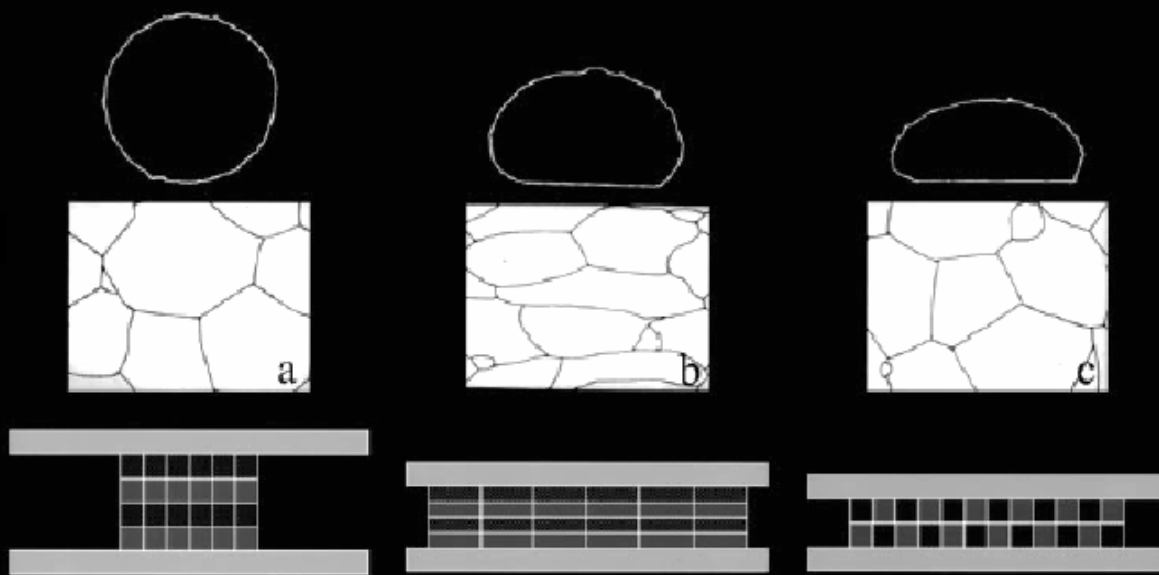
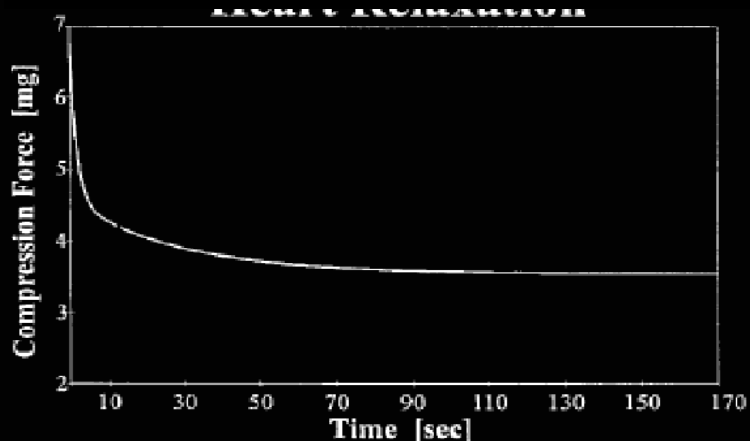
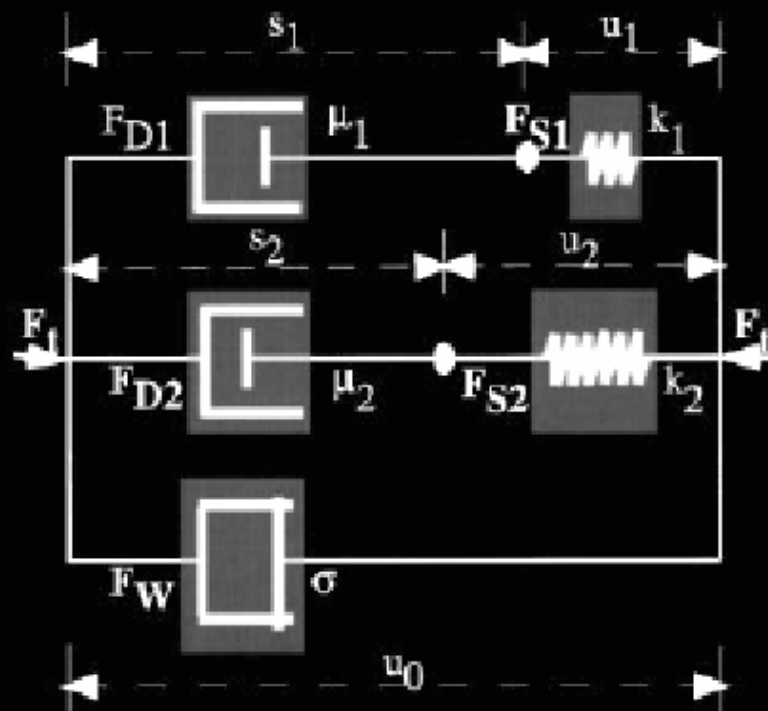
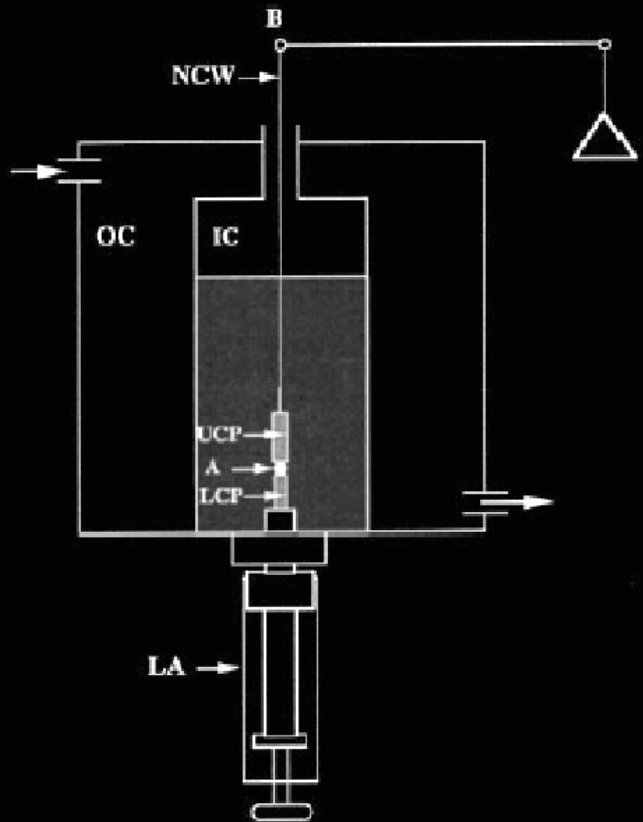

Forgacs et al., 1998

Mechanikai modell:

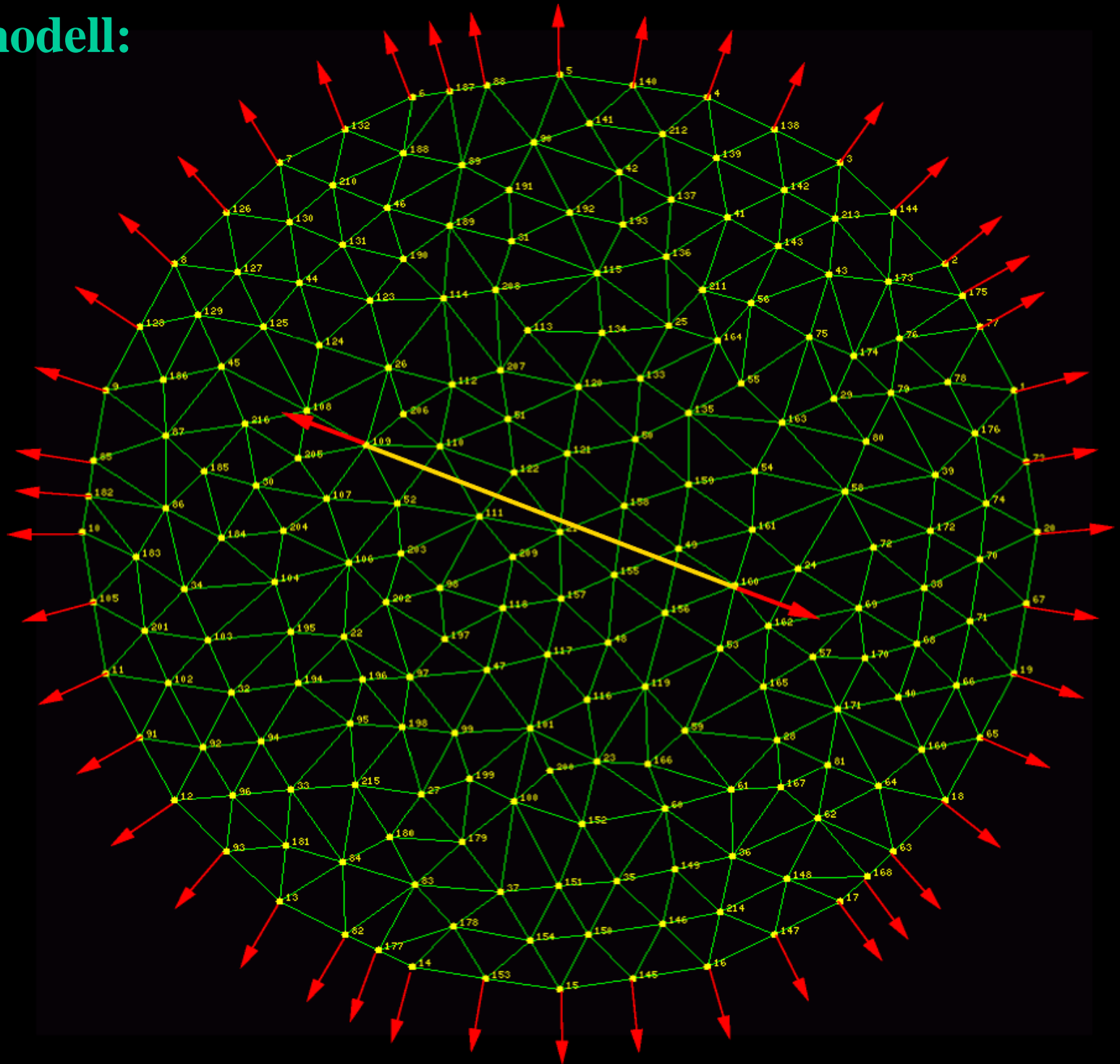

Deformációk számolása

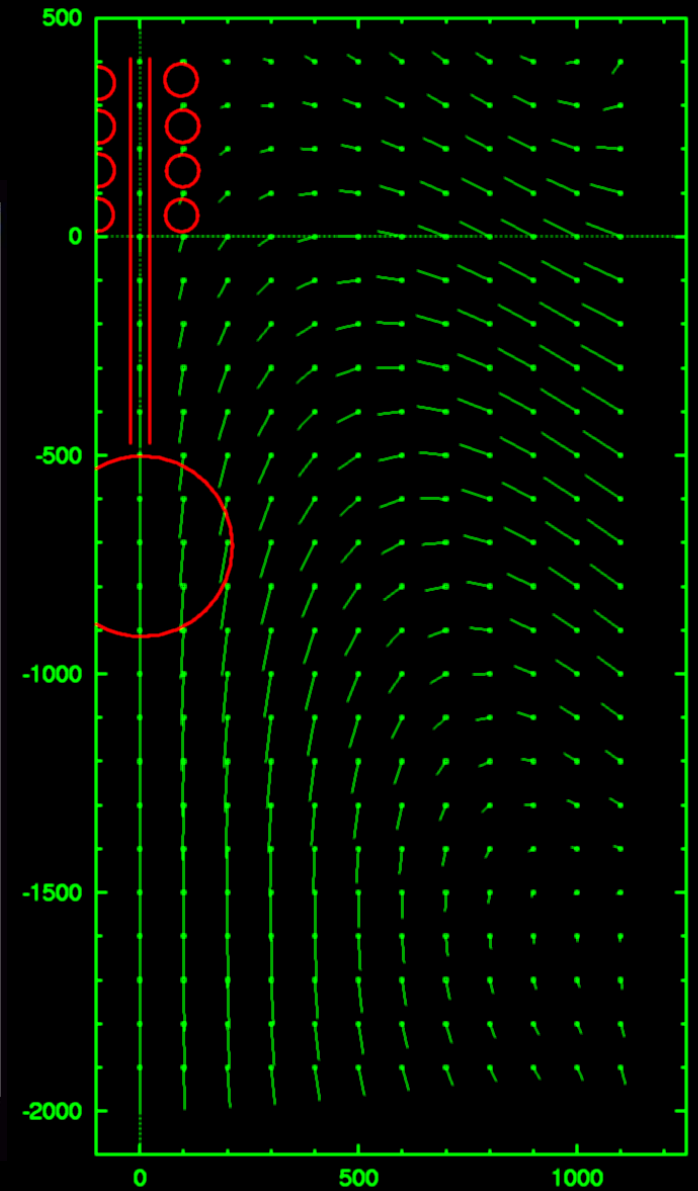
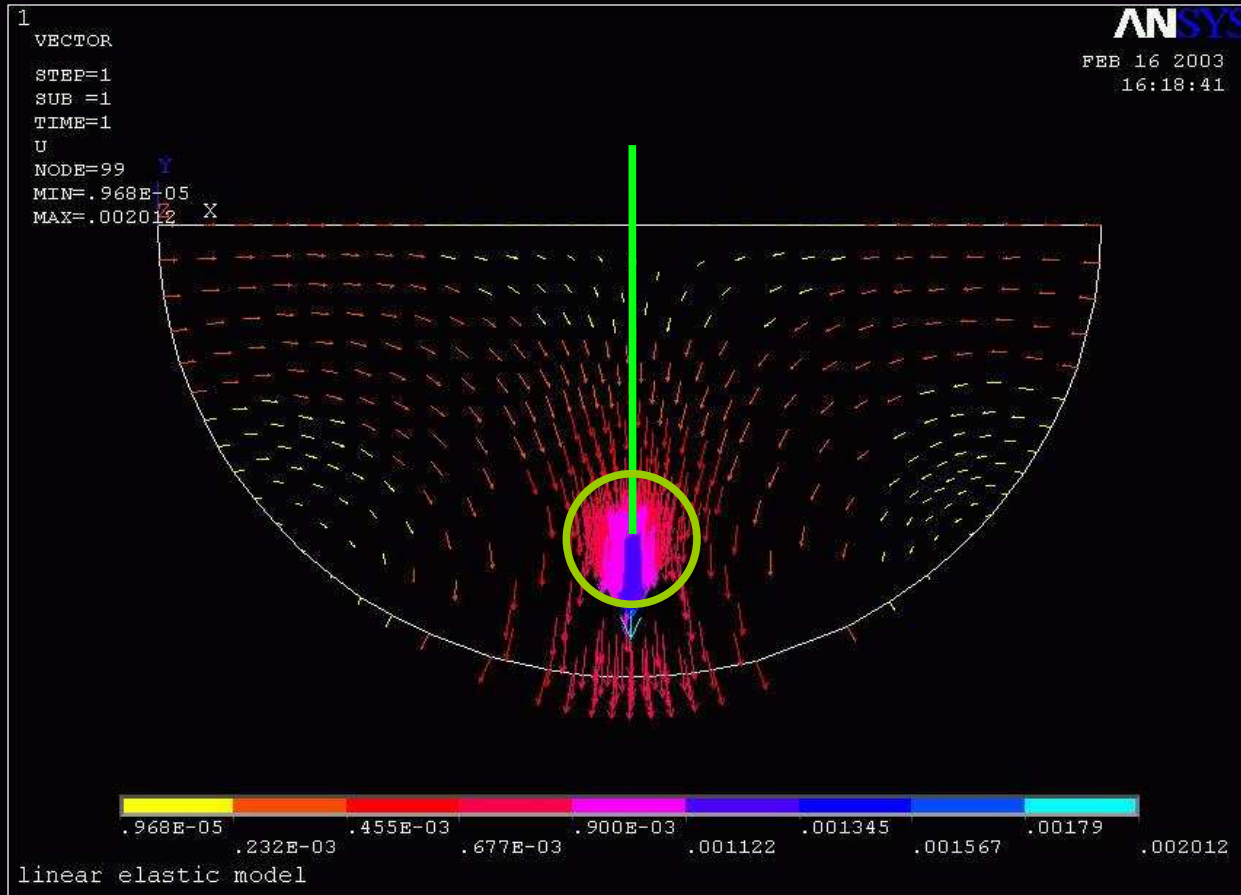

A jövő: mesterséges szövetek?

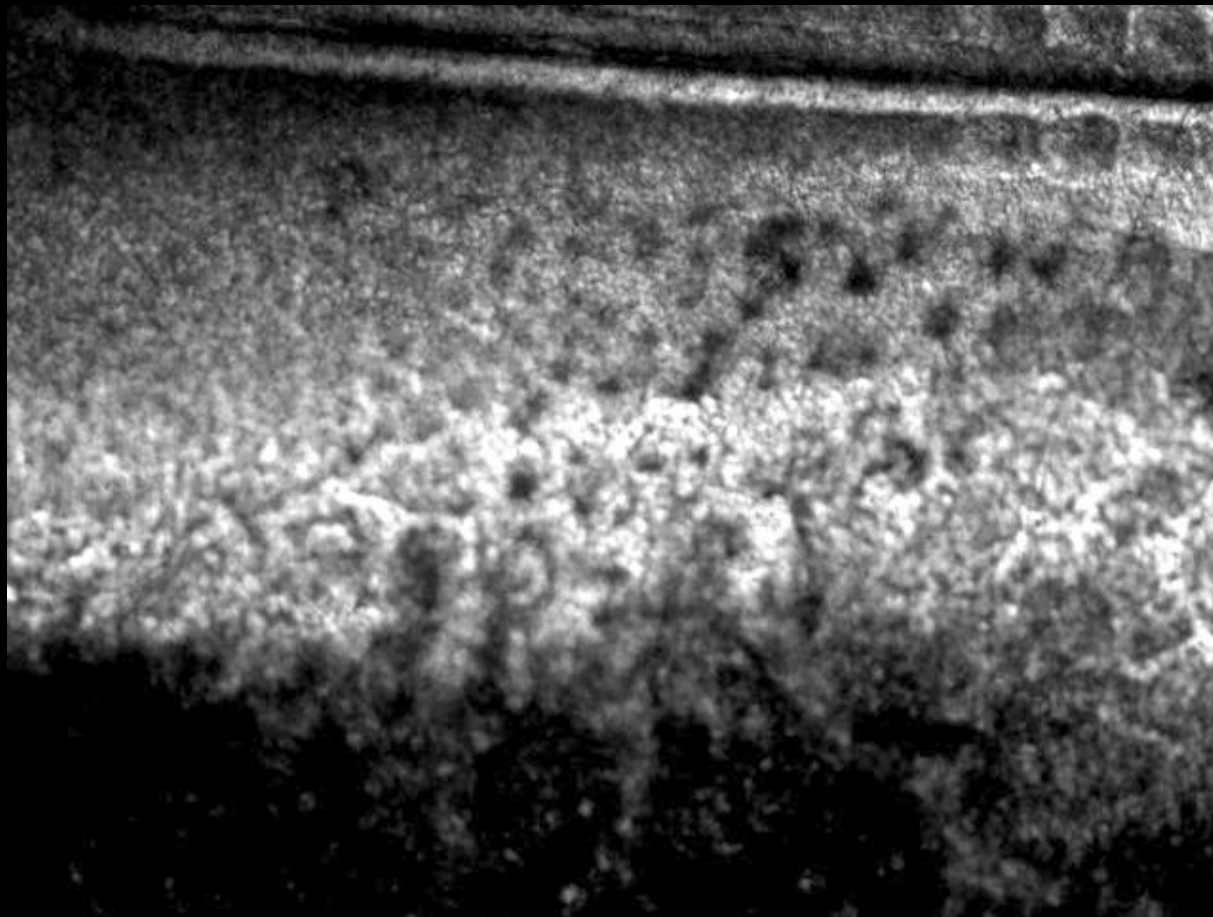

Somitogenesis core oscillator: “excitable medium”

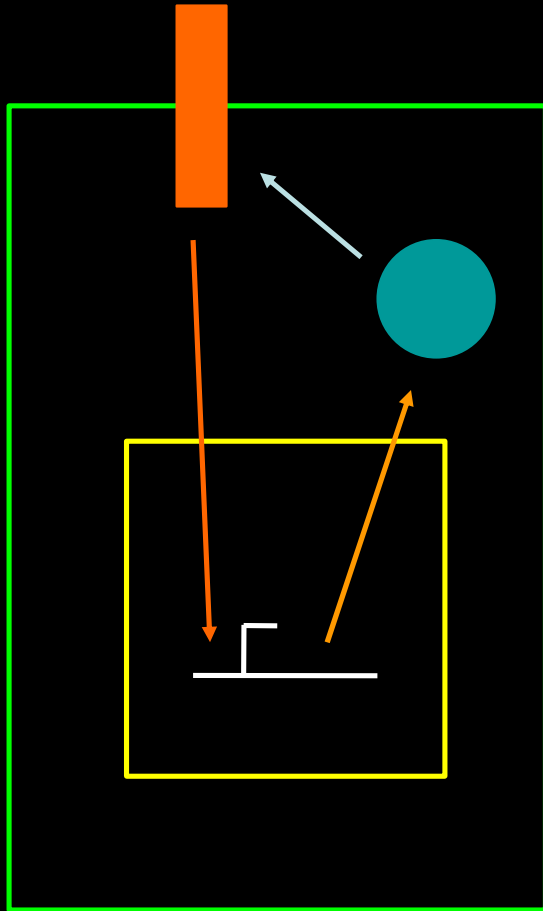

Somitogenesis core oscillator: “excitable medium”

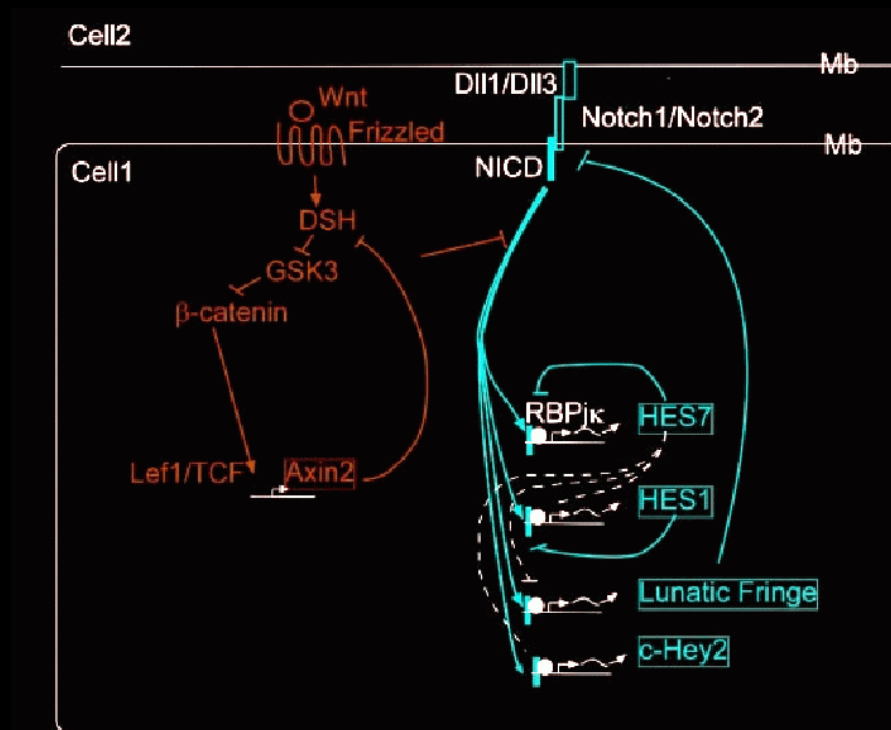
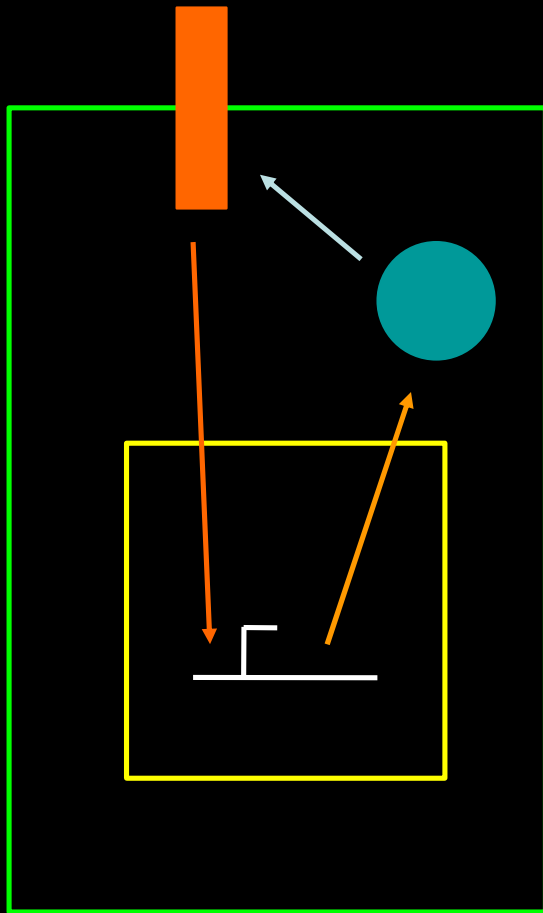

Somitogenesis core oscillator: “excitable medium”

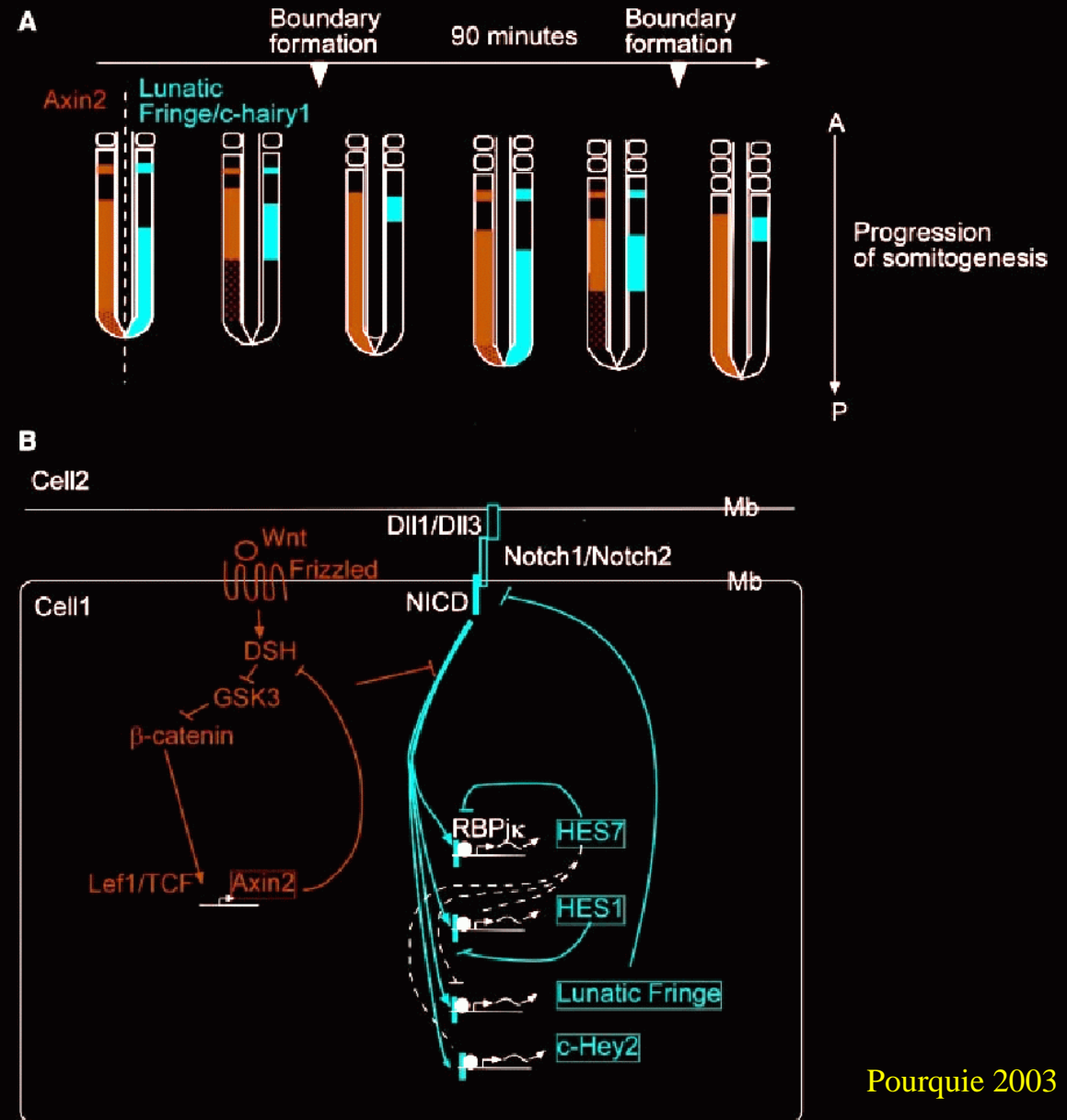
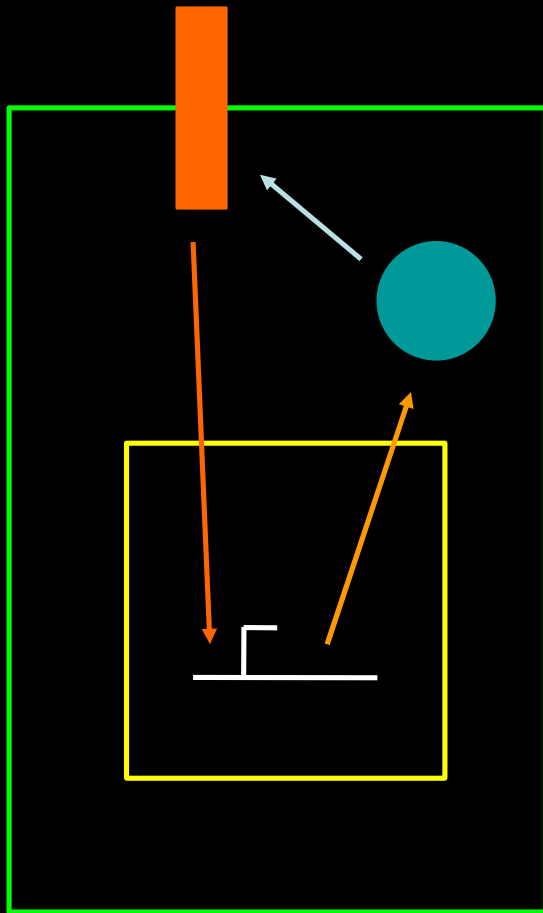

Spatial positioning: FGF8 gradient

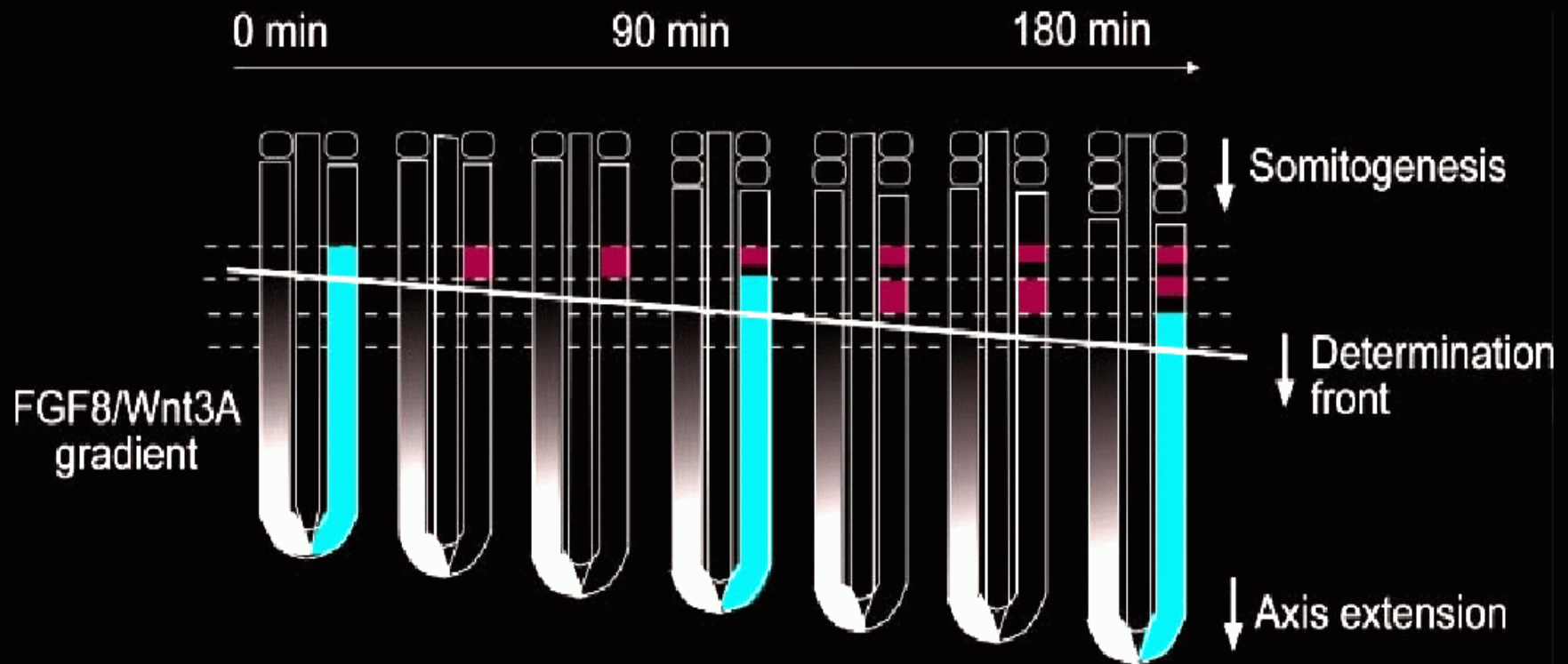

Gene expression monitoring in individual cells

